

LBNL Precision Measurement



One Cyclotron Road, 77/125
 Berkeley CA, 94720
 Ph. (510) 486-7611

Measurement Plan
 LHC Petal Vertical 1









Date
 October 28, 2008

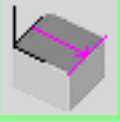

Order
 * order *

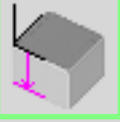
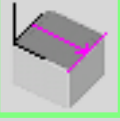
Length unit
 MM

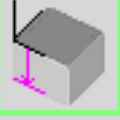
Time
 2:47:33 pm

Incremental Part Number
 1

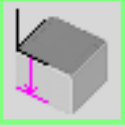
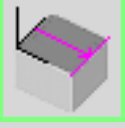
	Actual	Nominal	Upper Tol.	Lower Tol.	Deviation
 Flatness Plane Top	0.3041	0.0000	0.0500		0.2541 0.3041
 Flatness Plane Plane Bottom	0.2029	0.0000	0.0500		0.1529 0.2029
 Parallel Plane Bottom to Plane Top	0.3351	0.0000	0.0500		0.2851 0.3351
 X Value_Sphere1	0.0000	0.0000	0.0500	-0.0500	 0.0000
 Y Value_Sphere1	64.4556	64.4630	0.1500	-0.1500	- -0.0075
 Z Value_Sphere1	0.0000	0.0000	0.0500	-0.0500	 0.0000
 X Value_Sphere2	0.0000	0.0000	0.0500	-0.0500	 0.0000
 Y Value_Sphere2	-64.4556	-64.4630	0.1500	-0.1500	- 0.0075
 Z Value_Sphere2	0.0000	0.0000	0.0500	-0.0500	 0.0000
 X Value_Sphere3	671.2464	671.2695	0.3000	-0.3000	- -0.0230

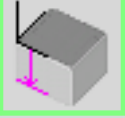
	Actual	Nominal	Upper Tol.	Lower Tol.	Deviation
 Y Value_Sphere3 -17.9387	-18.0599	0.1000	-0.1000	0.0212 0.1212	
 Z Value_Sphere3 0.0000	0.0000	0.0500	-0.0500	 0.0000	
 X Value_Sphere4 671.2492	671.2758	0.3000	-0.3000	- -0.0266	
 Y Value_Sphere4 17.7234	17.6032	0.1000	-0.1000	0.0202 0.1202	
 Z Value_Sphere4 0.1099	0.1492	0.0500	-0.0500	--- -0.0393	

LHC Petal Vertical 10/28/08

Top Plane Flatness

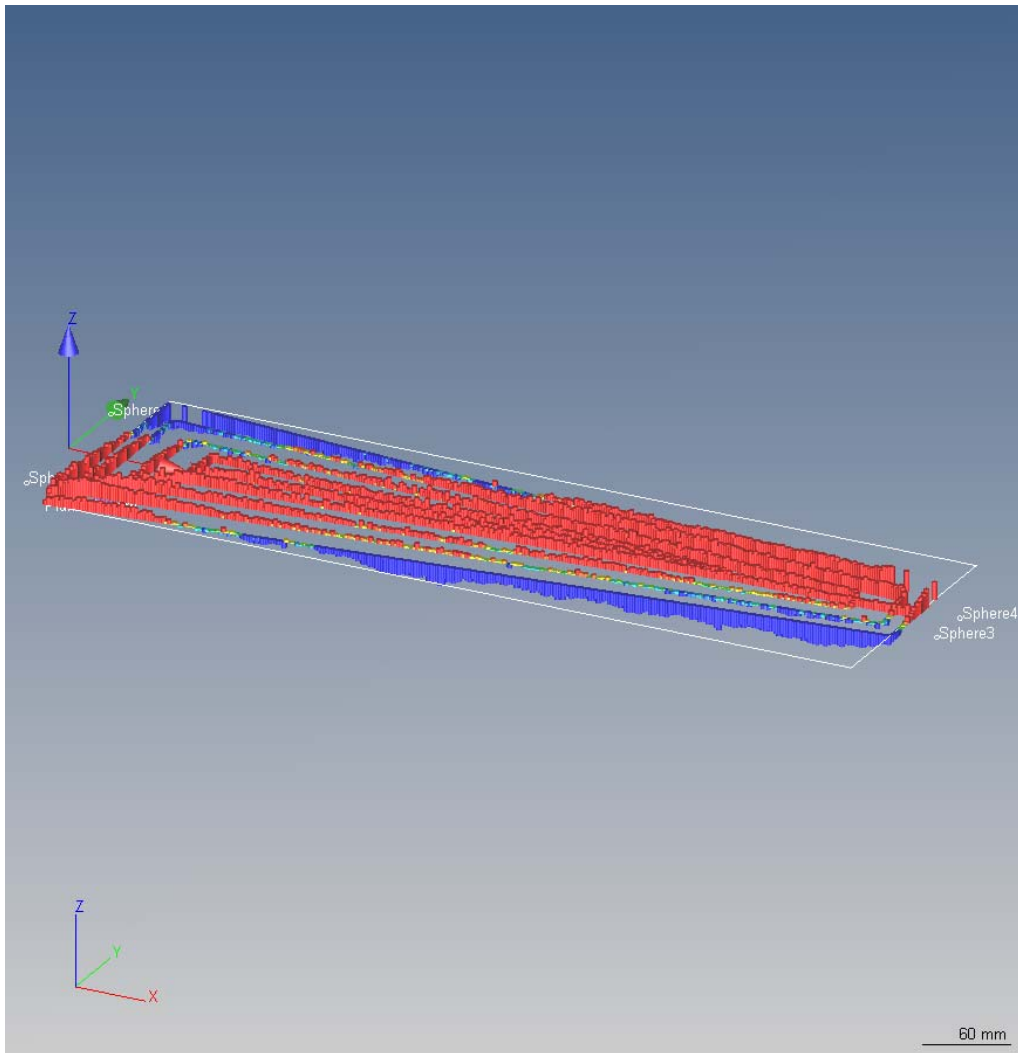

Bottom Plane

