

XI ICFA School on Instrumentation in Particle Physics

Bariloche, Argentina , January 11 – 22 , 2010

Electronics and Signal Processing

Helmuth Spieler

Physics Division, Lawrence Berkeley National Laboratory

spieler@LBL.gov

*These course notes will be posted together with additional tutorials at
<http://www-physics.lbl.gov/~spieler>*

or simply Google “spieler detectors”

*More detailed discussions in
H. Spieler: Semiconductor Detector Systems, Oxford University Press, 2005*

Course Contents

1. Introduction

- Why understand front-end electronics?
- What determines sensitivity or resolution?
- Examples

2. Signal Formation and Acquisition

- Detector pulses
- Voltage vs. Current Mode Amplifiers
- Charge-Sensitive Amplifier
- Frequency and Time Response

3. Electronic Noise

- Thermal Noise
- Shot Noise
- Low Frequency (“ $1/f$ ”) Noise
- Signal-to-Noise Ratio vs. Detector Capacitance

4. Signal Processing I

- Requirements
- Shaper Examples
- Pulse Shaping and Signal-to-Noise Ratio

5. Signal Processing II

- Threshold discriminator systems
- Timing Measurements
- Digitization
- Digital Signal Processing

6. Why Things Don't Work

Why understand front-end electronics?

Energy resolution enables recognition of structure in energy spectra.

Optimizing energy resolution often depends on electronics.

Comparison of NaI(Tl) scintillation detector and Ge semiconductor diode detector.

- Resolution in NaI(Tl) is determined by the scintillator.
- Resolution of the Ge detector depends significantly on electronics.

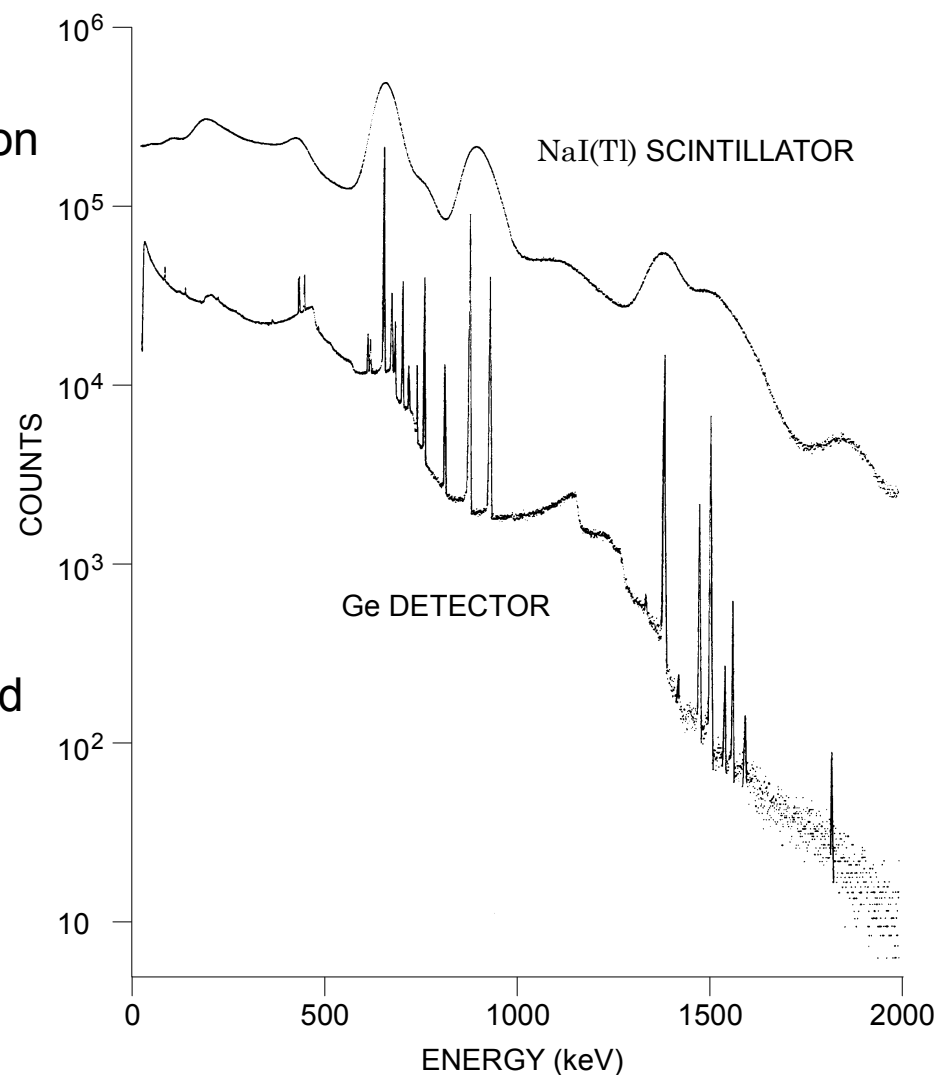

J.Cl. Philippot, IEEE Trans. Nucl. Sci. **NS-17/3** (1970) 446

Energy resolution is also important in experiments that don't measure energy.

Energy resolution improves sensitivity because

signal-to-background ratio improves with better resolution.

(signal counts in fewer bins compete with fewer background counts)

In tracking detectors a minimum signal-to-background ratio is essential to avoid fake hits.

Achieving the required signal-to-noise ratio with minimized power dissipation is critical in large-scale tracking detectors.

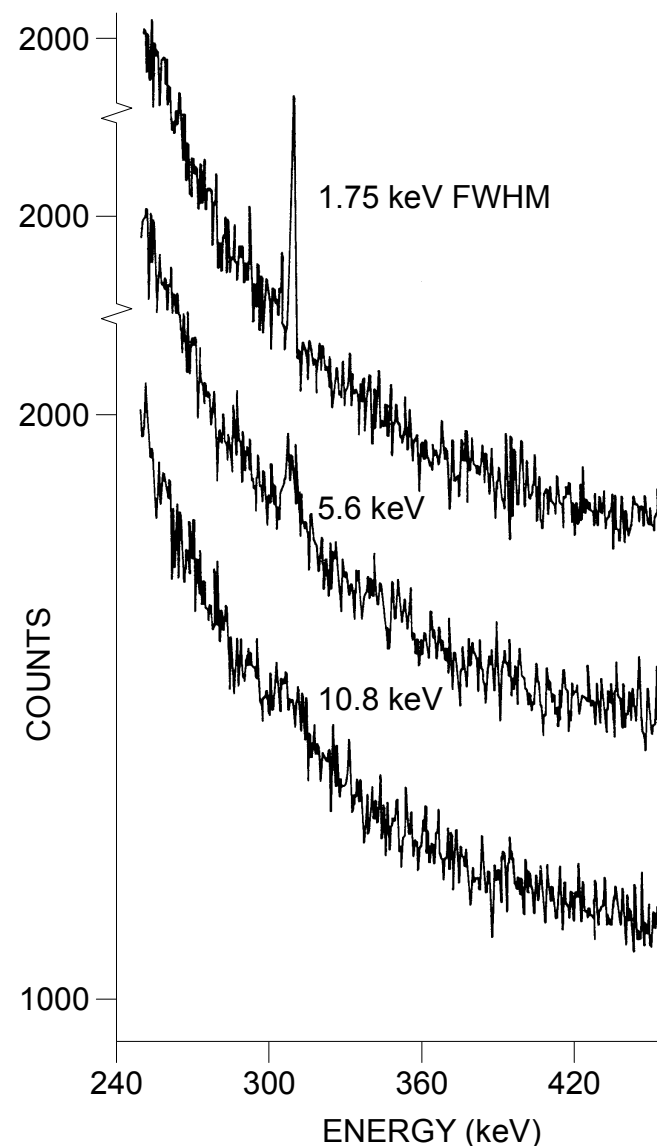

G.A. Armantrout *et al.*, IEEE Trans. Nucl. Sci. **NS-19/1** (1972) 107

Recognizing overall contributions to signal sensitivity does not require detailed knowledge of electronics engineering.

It does require a real understanding of basic classical physics.

i.e. recognize which aspects of physics apply in practical situations

... nope, real life doesn't tell you which chapter to follow!

For physicists and electronics engineers to work together efficiently it is necessary that physicists understand basic principles so that they don't request things that cannot work.

A common problem is “wouldn't it be nice to have this ...”, which often adds substantial effort and costs – without real benefits.

What determines Resolution?

1. Signal variance (e.g. statistical fluctuations) \gg Baseline Variance

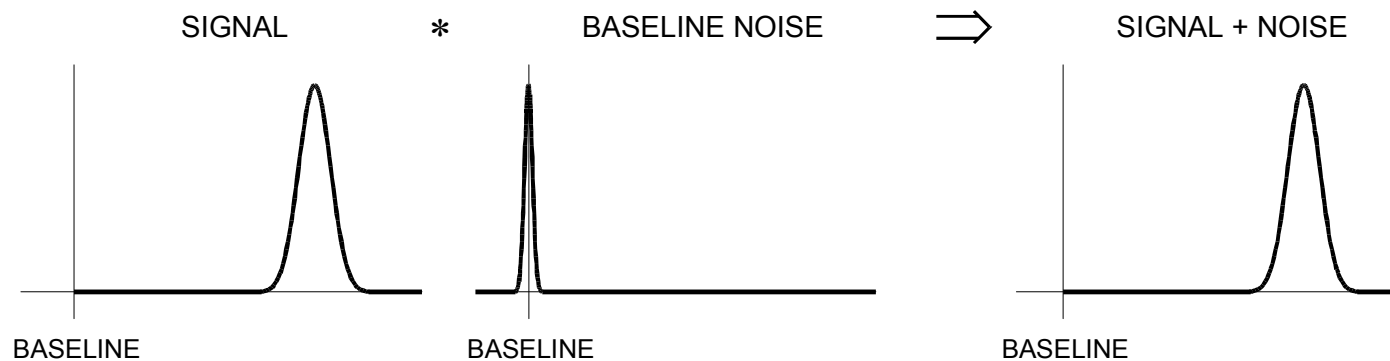

\Rightarrow Electronic (baseline) noise not important

Examples:

- High-gain proportional chambers
- Scintillation Counters with High-Gain PMTs

e.g. 1 MeV γ -rays absorbed by NaI(Tl) crystal

Number of photoelectrons: $N_{pe} \approx 8 \cdot 10^4 [\text{MeV}^{-1}] \times E_\gamma \times QE \approx 2.4 \cdot 10^4$

Variance typically: $\sigma_{pe} = N_{pe}^{1/2} \approx 160$ and $\sigma_{pe} / N_{pe} \approx 5 - 8\%$

Signal at PMT anode (assume Gain = 10^4): $Q_{sig} = G_{PMT} N_{pe} \approx 2.4 \cdot 10^8$ el and $\sigma_{sig} = G_{PMT} \sigma_{pe} \approx 1.2 \cdot 10^7$ el

whereas electronic noise easily $< 10^4$ el

2. Signal Variance \ll Baseline Variance

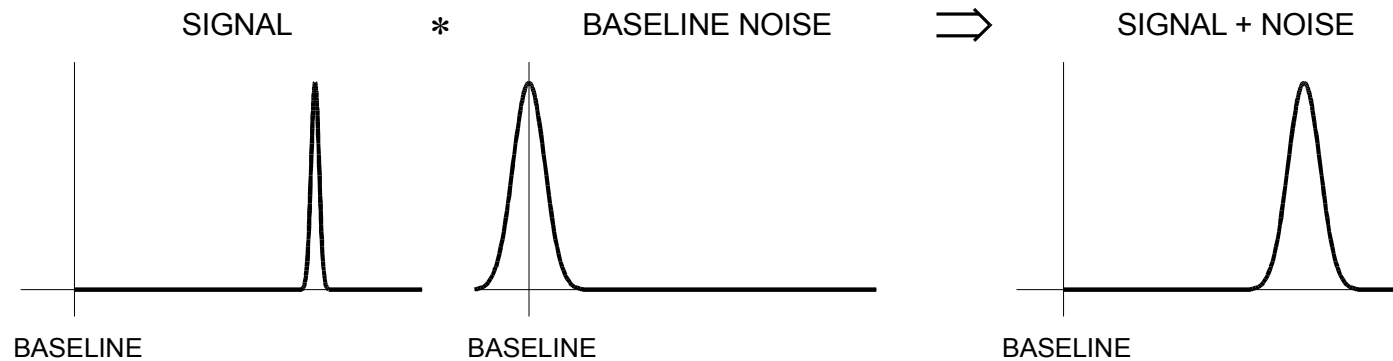

\Rightarrow Electronic (baseline) noise critical for resolution

- Examples:
- Gaseous ionization chambers (no internal gain)
 - Semiconductor detectors

e.g. in Si : Number of electron-hole pairs $N_{ep} = \frac{E_{dep}}{3.6 \text{ eV}}$

Variance $\sigma_{ep} = \sqrt{F \cdot N_{ep}}$ (where F = Fano factor ≈ 0.1)

For 50 keV photons: $\sigma_{ep} \approx 40 \text{ el} \Rightarrow \sigma_{ep} / N_{ep} = 7.5 \cdot 10^{-4}$

Obtainable noise levels are 10 to 1000 el.

Baseline fluctuations can have many origins ...

pickup of external interference

artifacts due to imperfect electronics

... etc.,

but the (practical) fundamental limit is electronic noise.

Depends on noise sources and signal processing.

Sources of electronic noise:

- Thermal fluctuations of carrier motion
- Statistical fluctuations of currents

Both types of fluctuations are random in amplitude and time

⇒ Power distributed over wide frequency range

⇒ Contribution to energy fluctuations depends on signal processing

Many different types of detectors are used for radiation detection.

Nearly all rely on electronics.

Although detectors appear to be very different, basic principles of the readout apply to all.

- The sensor signal is a current.
- The integrated current $Q_S = \int i_S(t) dt$ yields the signal charge.
- The total charge is proportional to the absorbed energy.

Readout systems include the following functions:

- Signal acquisition
- Pulse shaping
- Digitization
- Data Readout

Example: Scintillation Detector

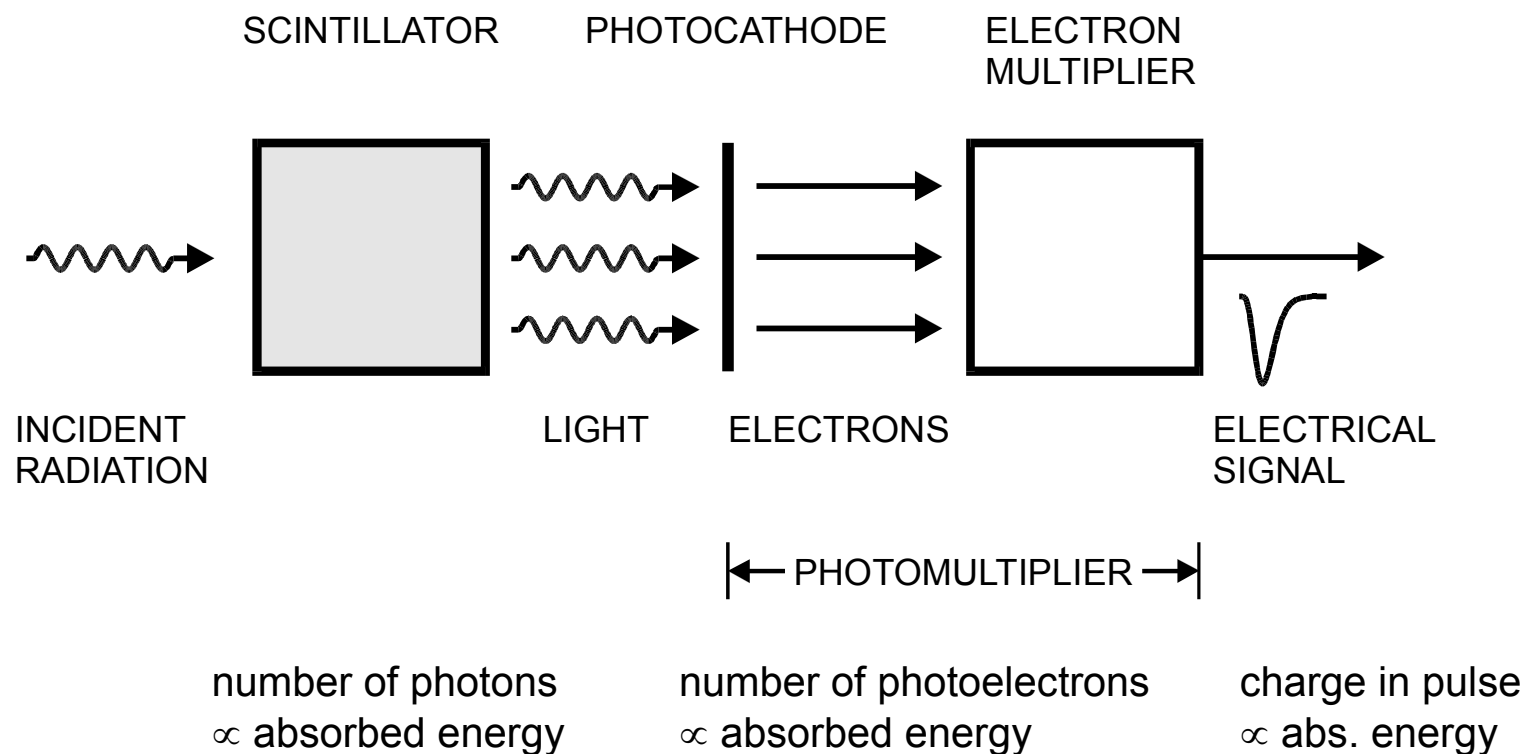

Readout

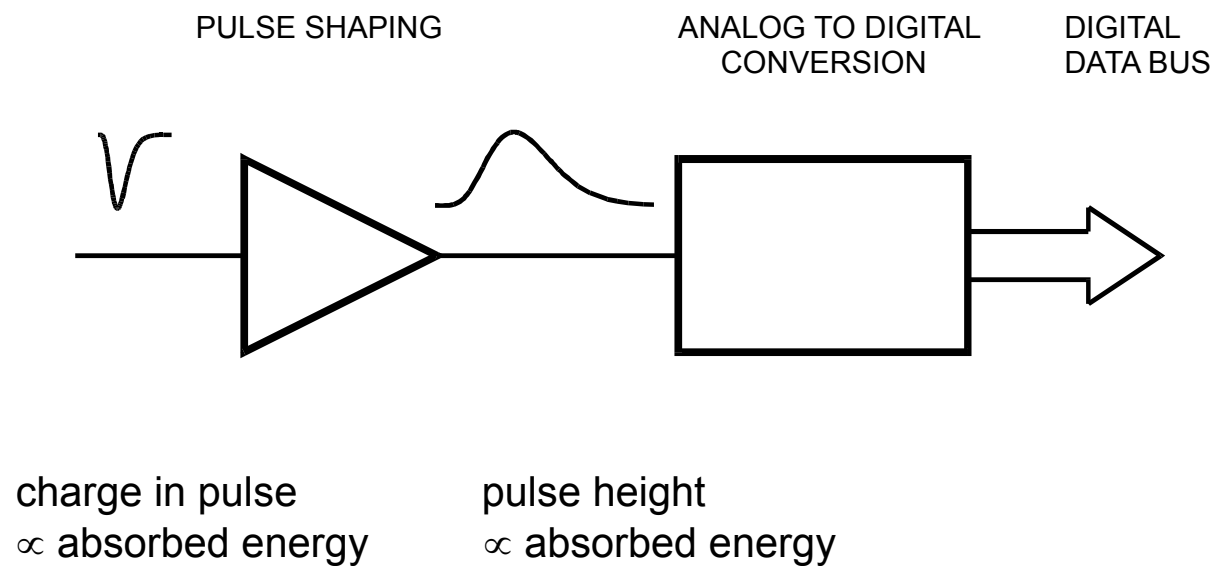

1. Basic Functions of Front-End Electronics

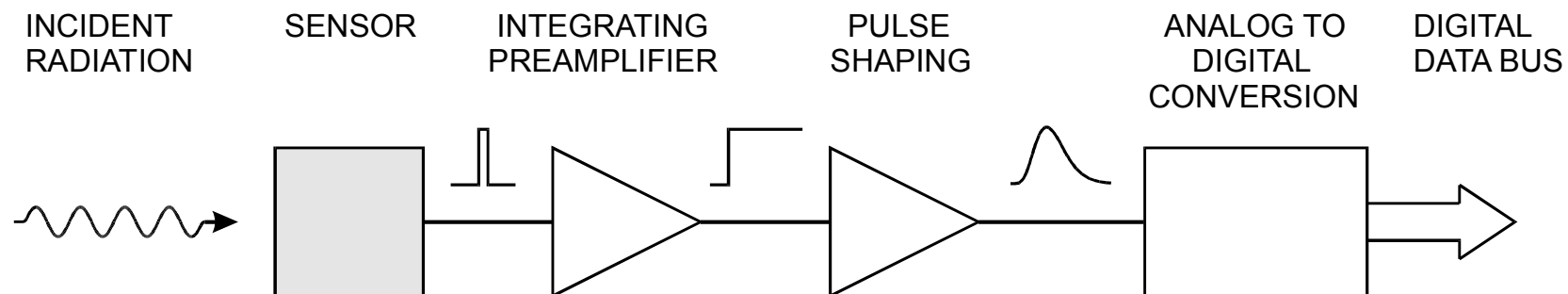

Pulse shaping can also be performed with digital circuitry:

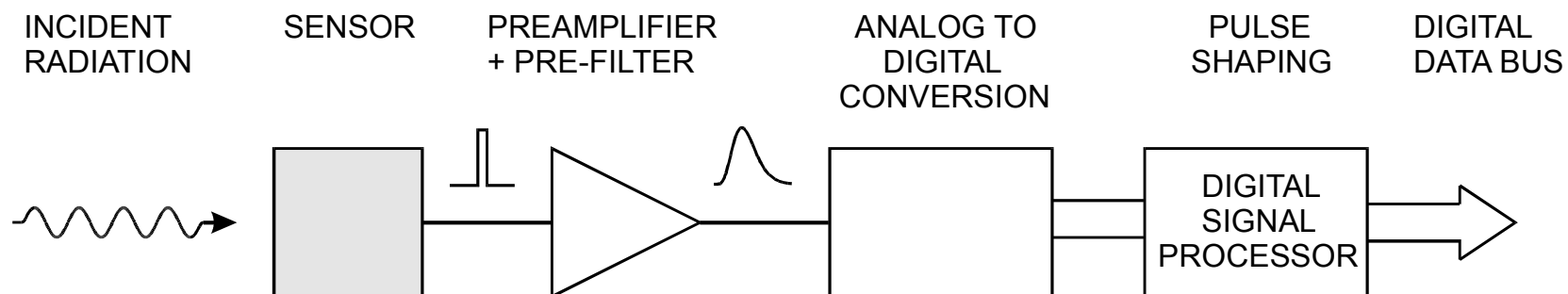

Many Different Implementations

“Traditional” Si detector system
for charged particle measurements

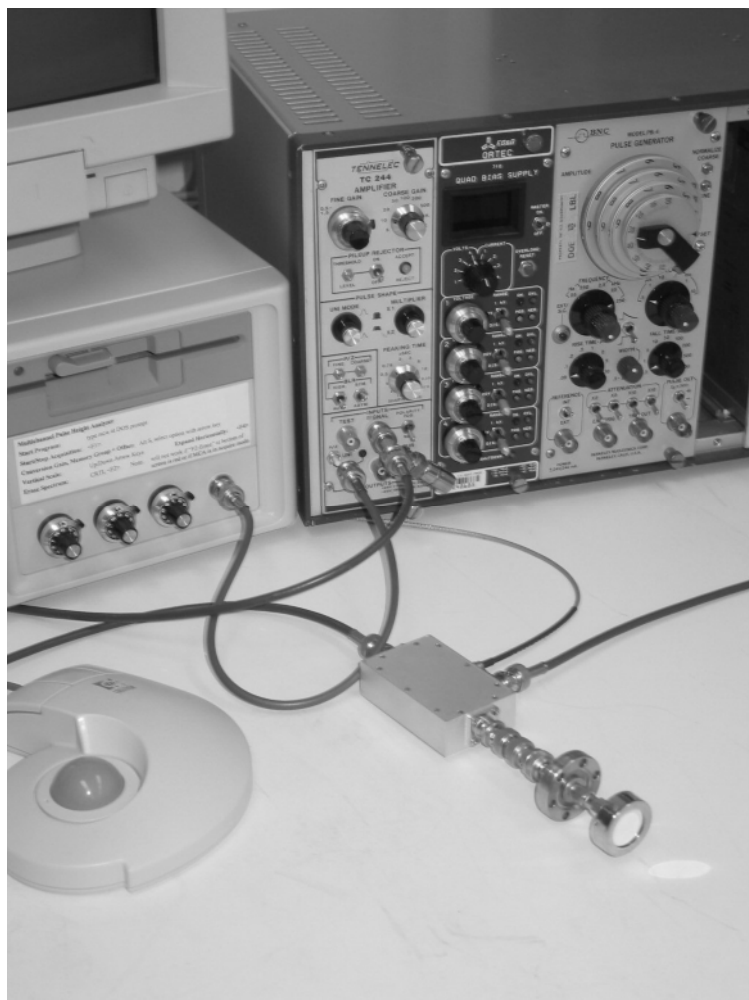

Tracking Detector Module (CDF SVX)
512 electronics channels on 50 μm pitch



Spectroscopy systems highly optimized!

By the late 1970s improvements were measured in %.

Separate system components:

1. detector
2. preamplifier
3. amplifier
 - adjustable gain
 - adjustable shaping
(unipolar + bipolar)
 - adjustable pole-zero cancellation
 - baseline restorer

Beam times typ. few days with changing configurations, so equipment must be modular and adaptable.

Today, systems with many channels are required in many fields.

In large systems power dissipation and size are critical, so systems are not necessarily designed for optimum noise, but *adequate* noise, and circuitry is tailored to specific detector requirements.

Large-Scale Readout Systems

Example: Si strip detector

On-chip Circuits

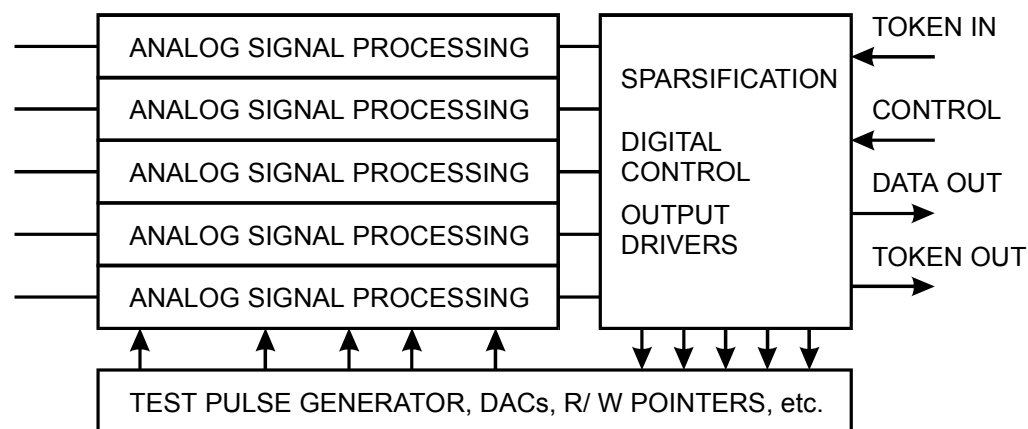
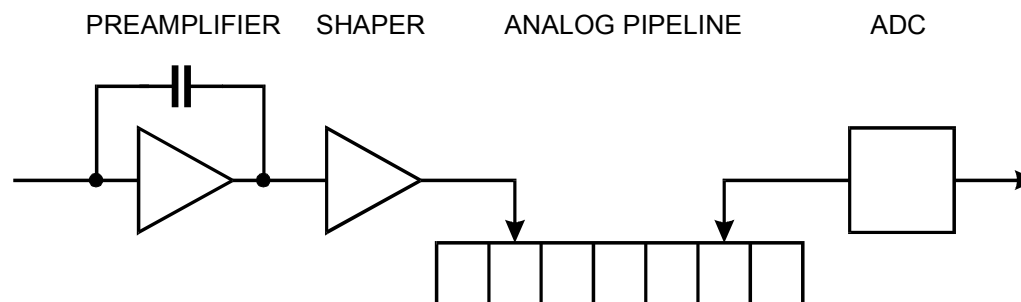

Inside a typical readout IC:

128 parallel channels of analog front-end electronics
 Logic circuitry to decode control signals, load DACs, etc.
 Digital circuitry for zero-suppression, readout

Readout of Multiple ICs

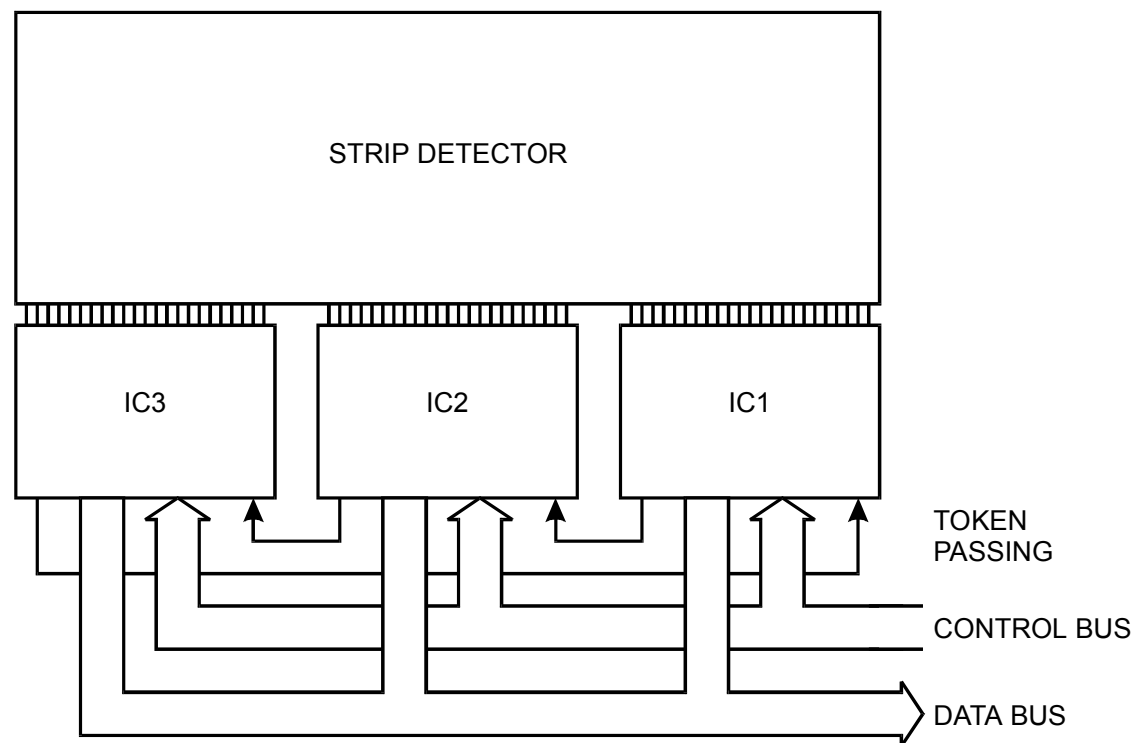

IC1 is designated as master.

Readout is initiated by a trigger signal selecting appropriate time stamp to IC1.

When all data from IC1 have been transferred, a token is passed to IC2.

When IC3 has finished, the token is passed back to IC1, which can begin a new cycle.

ATLAS Silicon Strip system (SCT): ABCD chips mounted on hybrid

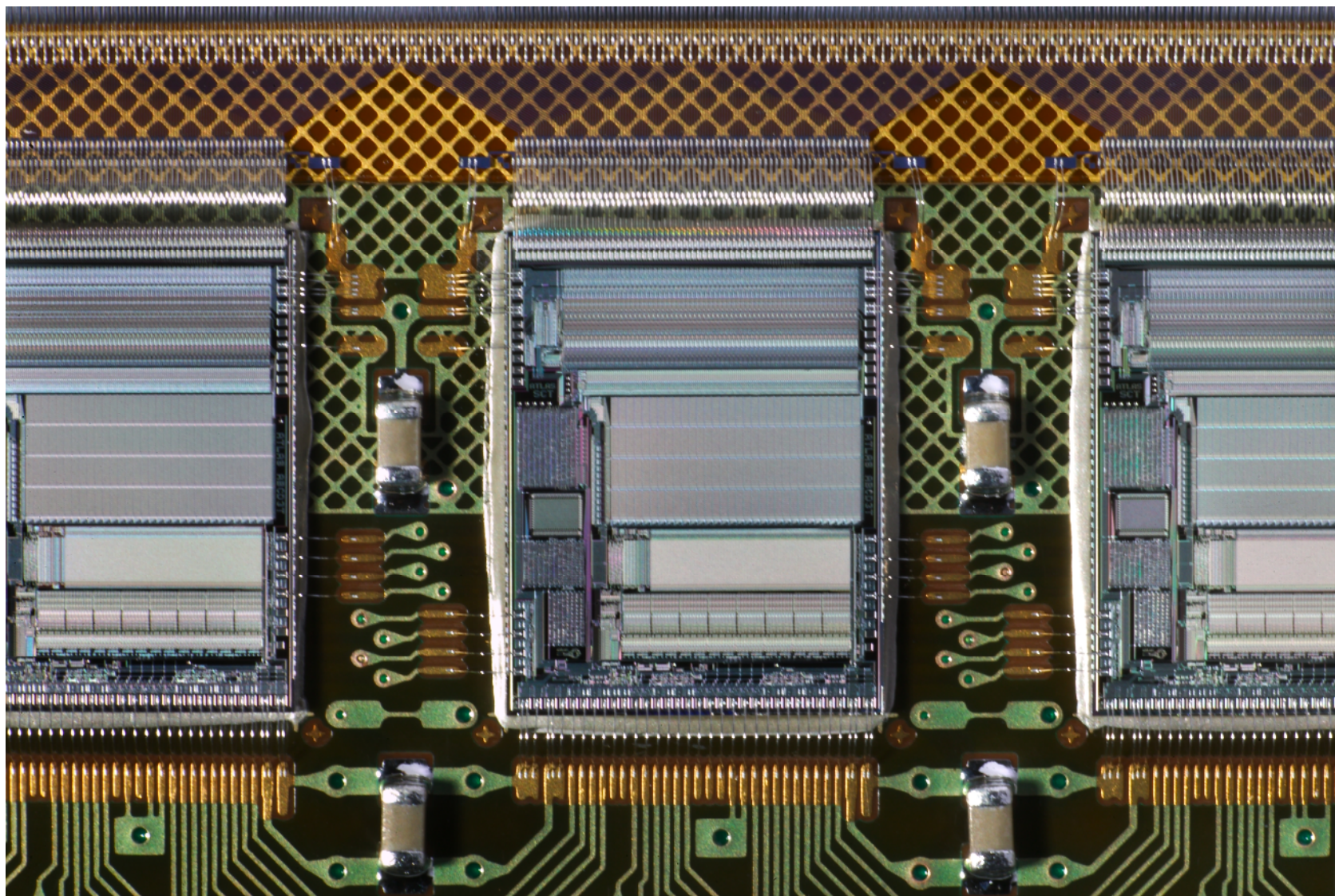

ATLAS SCT Detector Module

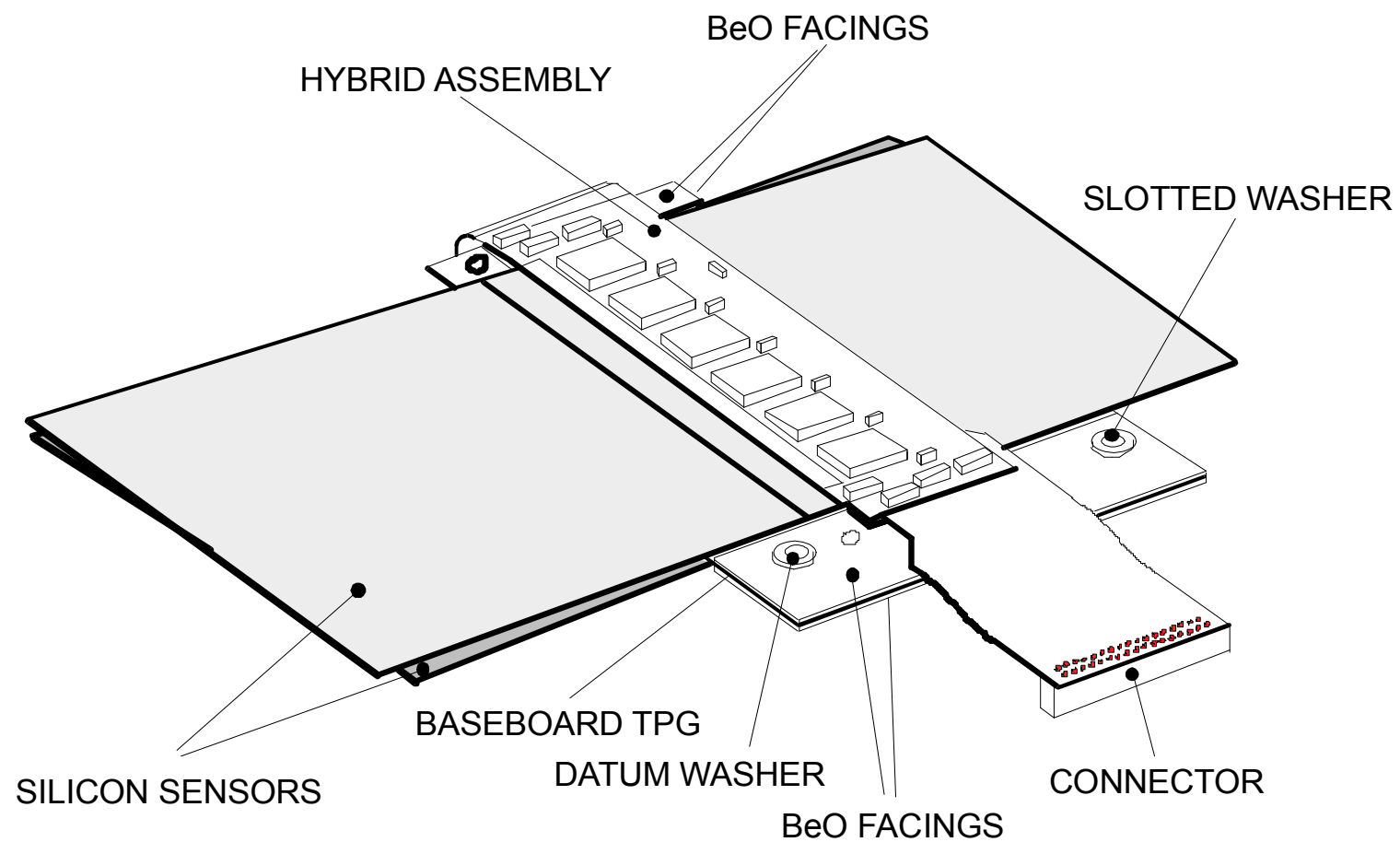

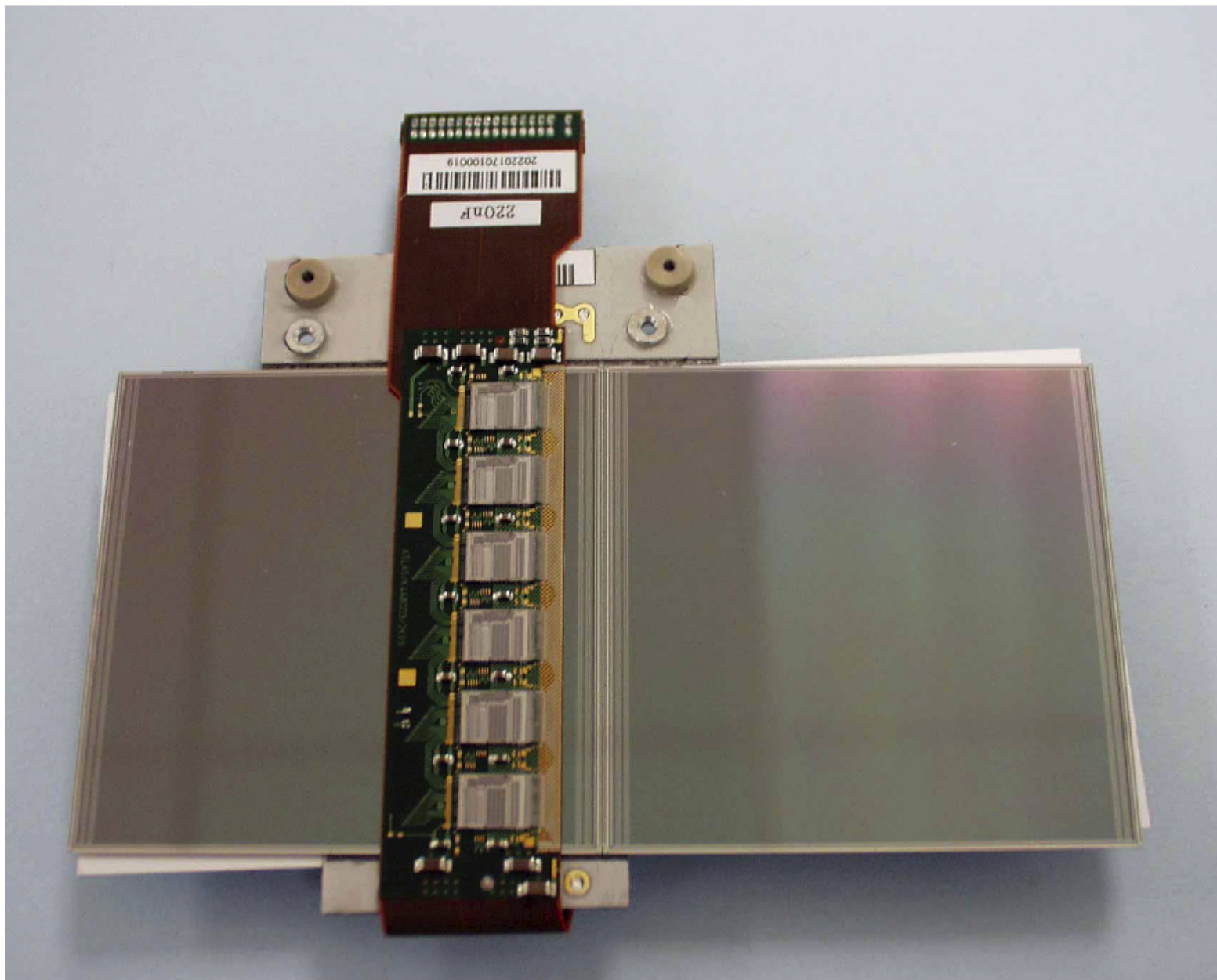

Cross Section of Module

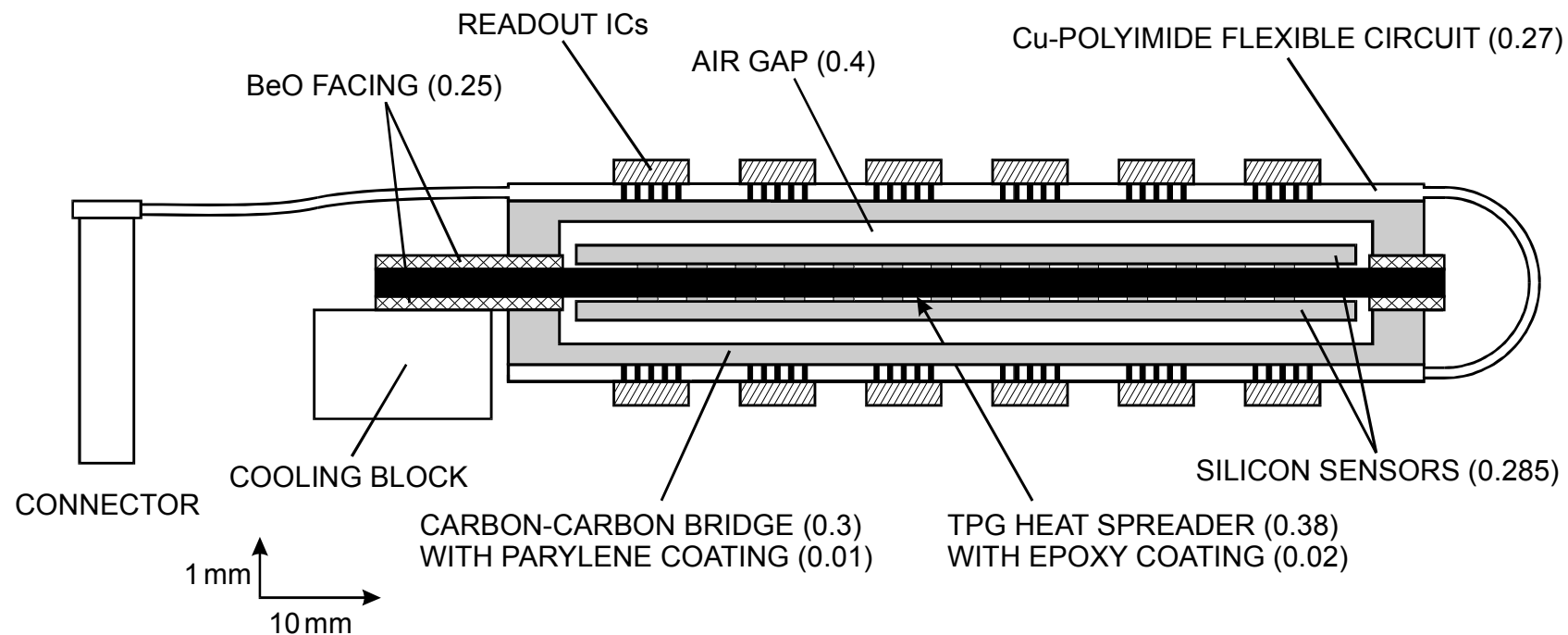

Design criteria depend on application

1. Energy resolution
2. Rate capability
3. Timing information
4. Position sensing

Large-scale systems impose compromises

1. Power consumption
2. Scalability
3. Straightforward setup + monitoring
4. Cost

Technology choices

1. Discrete components – low design cost
fix “on the fly”
2. Full-custom ICs – high density, low power, but
better get it right!

Successful systems rely on many details that go well beyond “headline specs”!