

I. Introduction

1. Why?	2
2. Examples	
Astronomical Imaging	7
Medical Imaging – Positron Emission Tomography	15
X-Ray Fluorescence	22
Vertex Detection in High-Energy Physics	28
Failure Analysis in Si Integrated Circuits	33
Detection of Gravity Waves	35
3. The Problem	37
4. Example Measuring System	45

WHY?

Radiation is the only observable in processes that occur on a scale that is either too brief or too small to be observed directly. It also is the only access to processes that are very far away.

Originally developed for atomic, nuclear and elementary particle physics, radiation detectors now are applied in many diverse areas of science, engineering and everyday life.

Progress in science is driven not just by the interplay of theory and experiment, but also by breakthroughs in instrumentation.

Types of Radiation:

a) charged particles

electrons, protons, atomic nuclei
+ many elementary particles

b) neutral particles

neutrons
+ many elementary particles
gravitons

c) photons

mm waves
light
x-rays
gamma rays

Most modern detectors convert the absorbed energy into an electrical signal.

The detection sensitivity depends on

- fluctuations in the detector
- fluctuations in the electronics

To maximize detection sensitivity one must consider

- signal formation in the detector
- coupling of the detector to the electronics
- fluctuations in the electronics

The interplay between detectors and electronics is an area rife with myths and misunderstood “general” principles.

Although detectors take on many forms to match a wide range of applications, a common set of basic principles can be applied to analyze and optimize their sensitivity.

However, the proper application of these principles often depends on many details.

The goal of this course is to develop an

- understanding of the basic principles and to
- show how these details hang together.

The development of detector systems is an interdisciplinary mix of physics and electronics.

For example, understanding of a modern tracking detector in high-energy physics or a medical imaging system requires knowledge of

- solid state physics
- semiconductor device physics
- semiconductor fabrication technology
- low-noise electronics techniques
- analog and digital microelectronics
- high-speed data transmission
- computer-based data acquisition systems

This is a great way to learn about the interplay between physics and technology!

Some examples as introduction....

- imaging in astronomy
(thanks to Steve Holland, Engineering Div. LBNL)
- medical imaging –
positron emission tomography
(thanks to Bill Moses, Life Sciences Div. LBNL)
- detection of trace elements by x-ray
fluorescence
(thanks to Joe Jaklevic, Engineering Div. LBNL)
- tracking detectors in high-energy physics
- failure analysis in silicon integrated circuits
- detection of gravity waves

1. Astronomical Imaging

(thanks to Steve Holland, Engineering Div. LBNL)

Practically all faint light imaging in astronomy relies on electronic sensors

- visible light
- IR
- UV
- x-rays

Example: Supernova Search

(S. Perlmutter et al., see www-physics.lbl.gov)

Reference Image

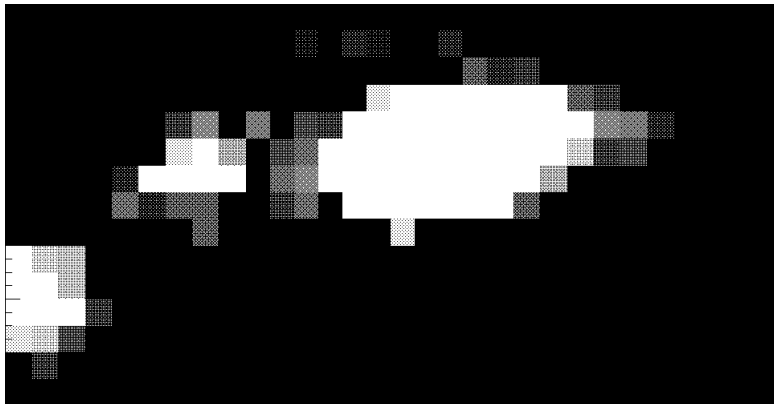

New Galaxy Image

↓ SN Candidate

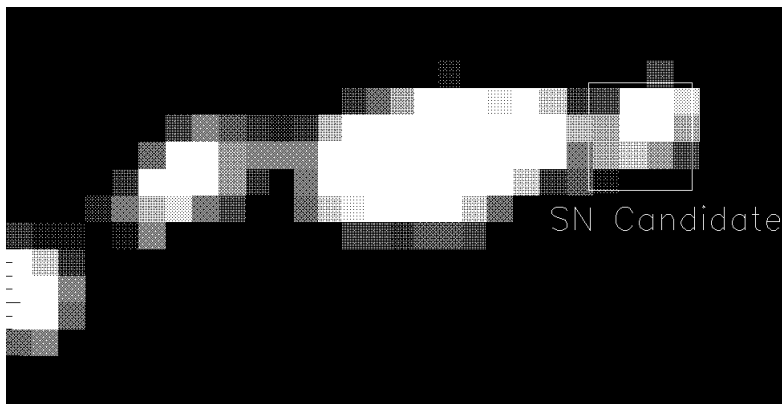

The image sensors are arrays of pixelated semiconductor detectors, called CCDs (charge coupled devices). Pixel size typ. 10 – 30 μm .

Planetary Nebula NGC7662 (CCD at -120°C)

Photon flux in outer halo is ~ 35 photons/s per pixel

Generated from 100 s exposures at different λ , Lick 1m



Similar CCDs are widely used in camcorders, but astronomical imaging requires much greater sensitivity and the ability to record *very* small signals (order 1 electron).

At LBNL a novel CCD has been developed in conjunction with the supernova group.

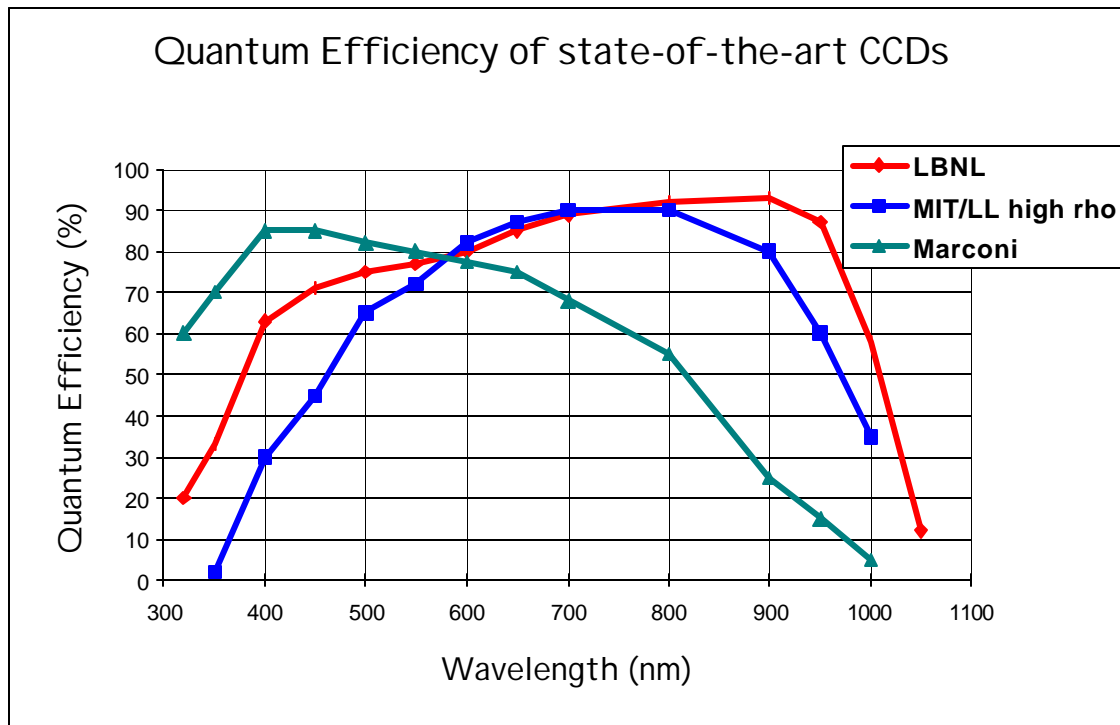

Use of a fully depleted substrate provides extended red response.

Since no thinning is required, yields increase and costs drop by a factor of 10 – 100.

Conventional CCD Structure

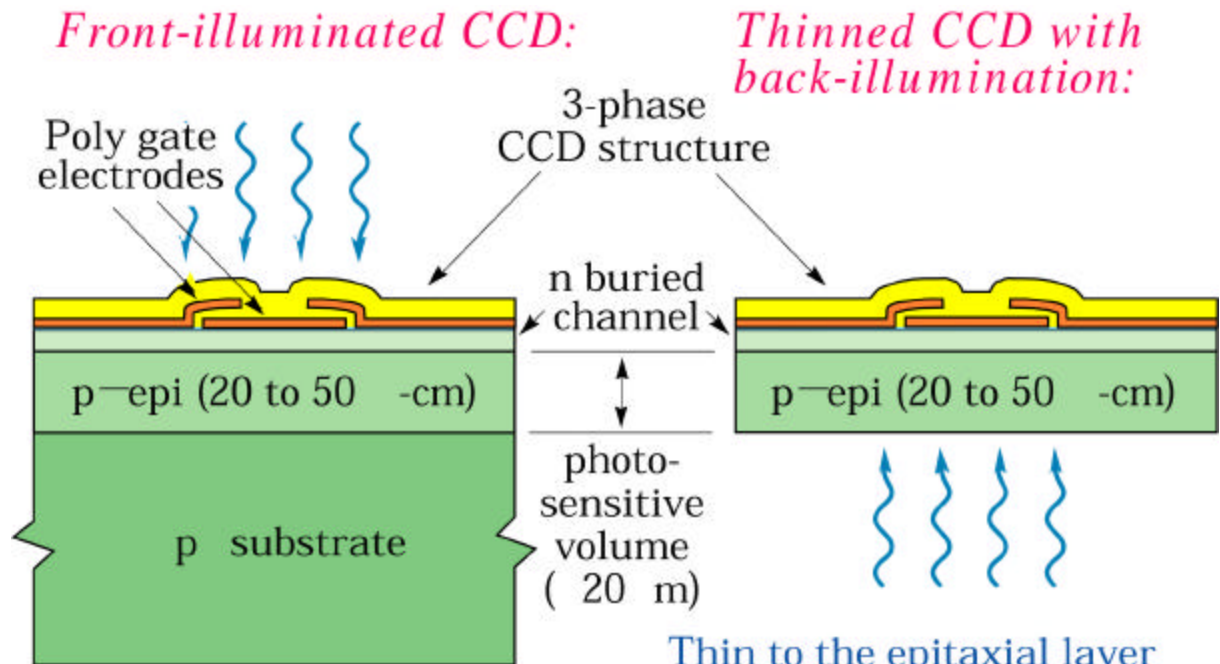

Drawbacks:

- 1) Poor blue response due to absorption in polysilicon gate electrodes
- 2) Poor near-IR response due to thinness of the epitaxial layer
- 3) Interference patterns due to gate structure

Drawbacks:

- 1) Thinning is difficult and expensive
- 2) Poor near-IR response
- 3) Interference (fringing)
- 4) Lateral diffusion in field-free region (degraded PSF)

Fully Depleted CCD

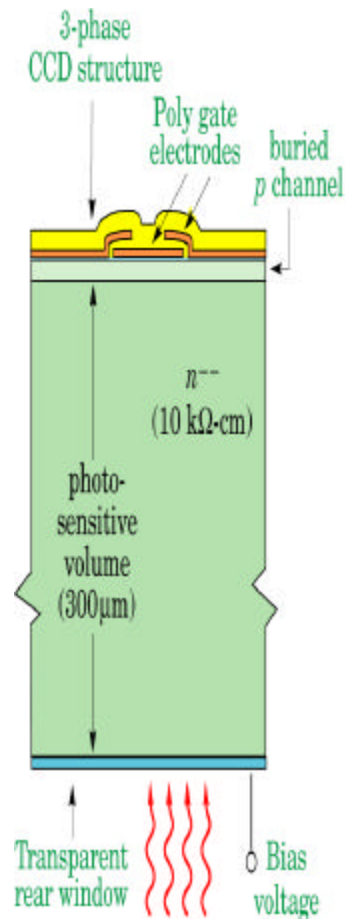

Advantages:

- 1) Conventional MOS processes with no thinning => "inexpensive"
- 2) Full quantum efficiency to $> 1 \mu\text{m}$ => no fringing
- 3) Good blue response with suitably designed rear contact
- 4) Radiation tolerant

Disadvantages:

- 1) Enhanced sensitivity to radiation (x-rays, cosmic rays, radioactive decay)

- high resistivity n -type substrate, fully depleted
- backside illumination
- transparent window with antireflection coating thin for good blue response
- 300 μm active thickness \Rightarrow good QE up to $\lambda = 1 \mu\text{m}$
- no costly thinning of devices

Comparison between thinned CCD (bottom/left) and deep depletion device. Interstellar dust tend to absorb in the blue, so extended red response of LBNL CCD shows features obscured in thinned CCDs.

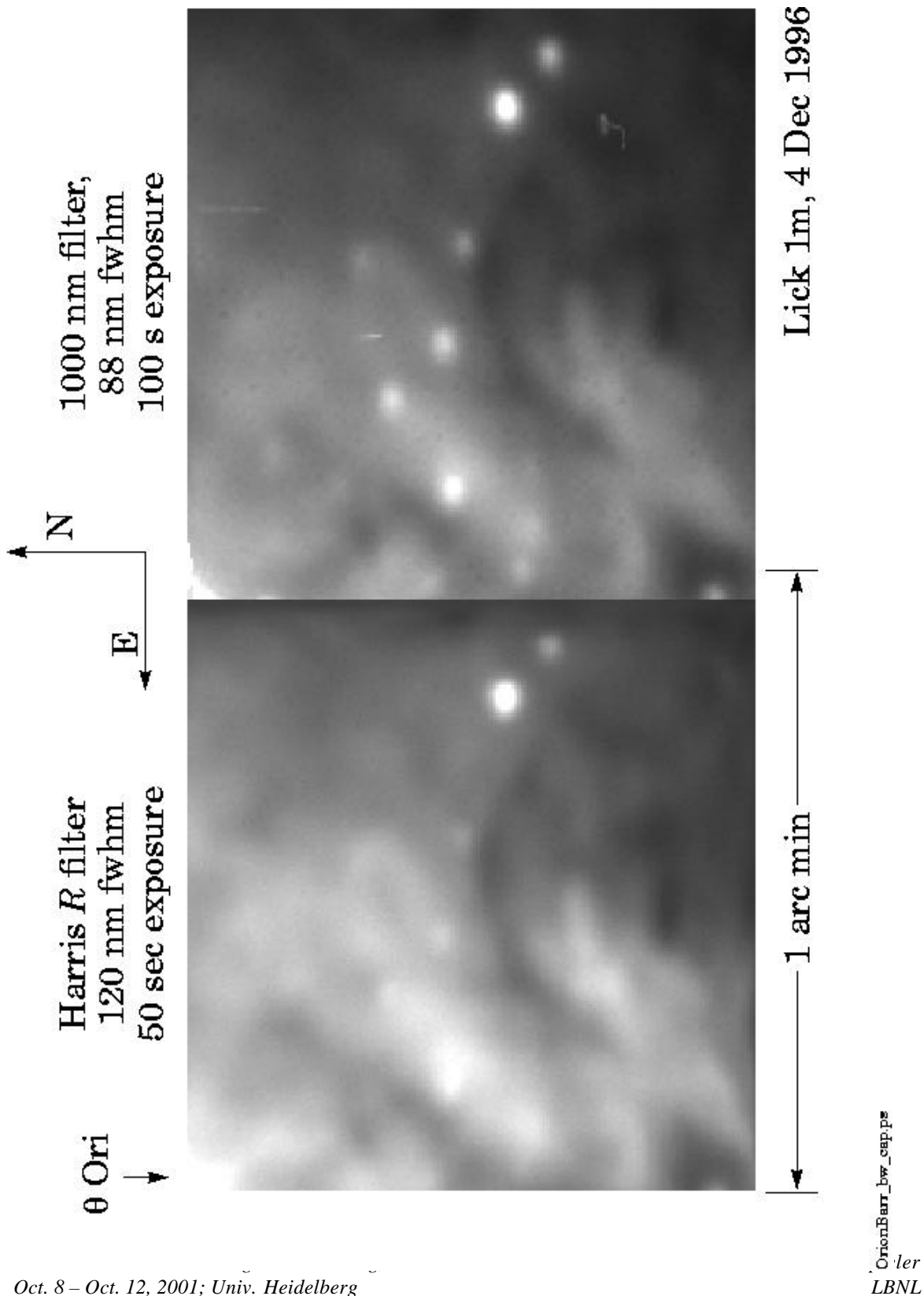

Low cost CCDs core of a new project:

SuperNova Acceleration Probe – SNAP

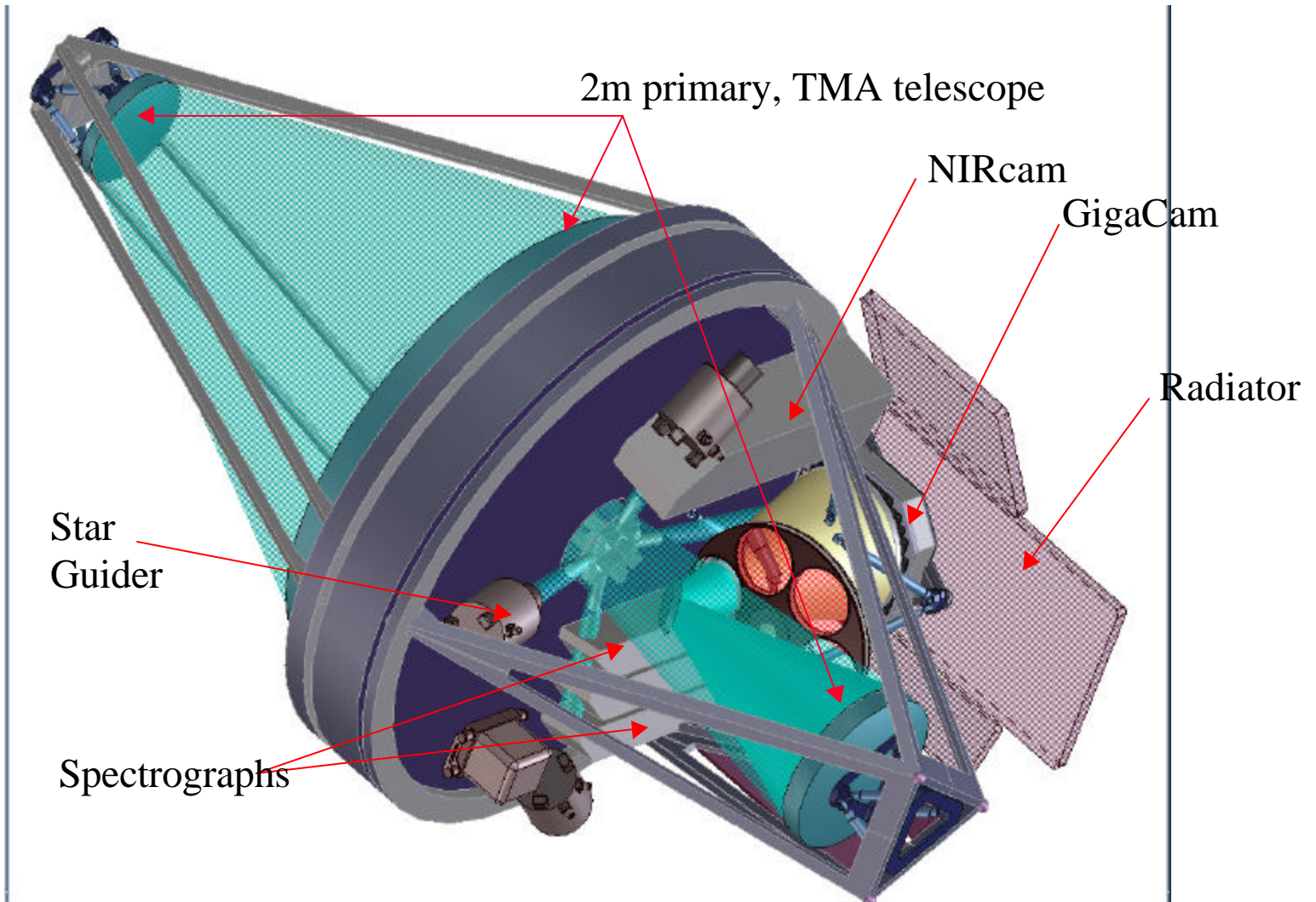

Extend supernova measurements to high red-shifts.

Gain better understanding of “dark energy”.

Combine many CCDs to form Gigapixel array

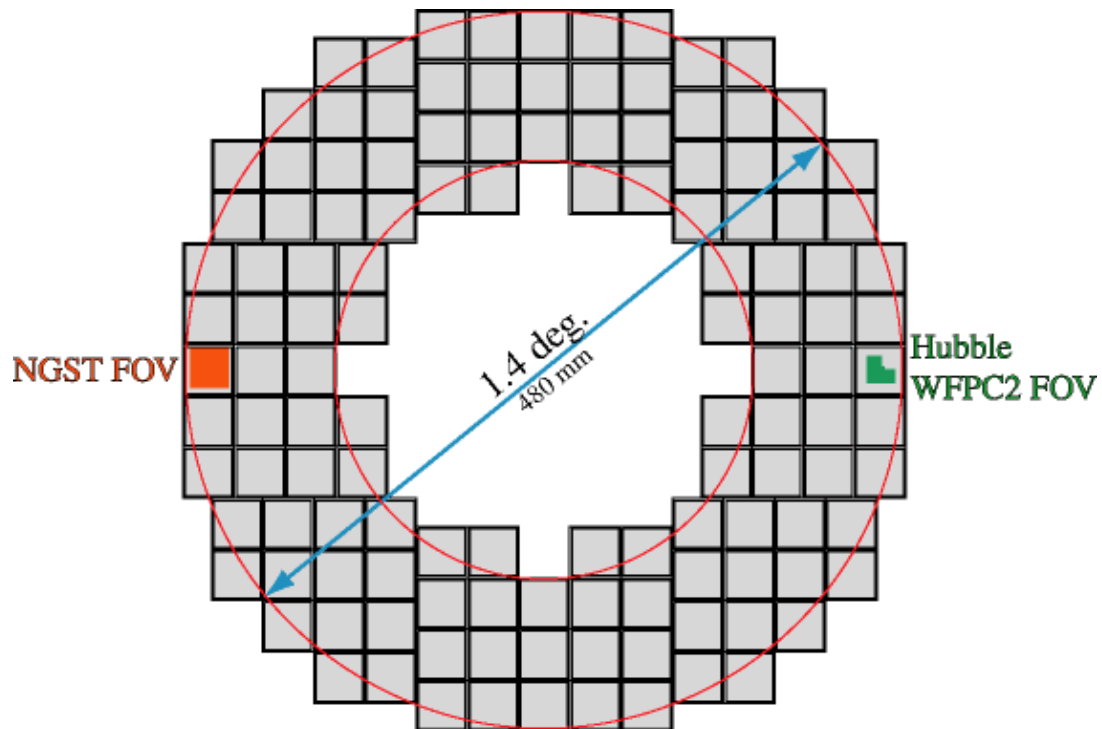

100 mm test wafer

includes

2K x 4K (15 μm),

1.5K x 4.8K (10.5 μm)

and

1.3K x 4.2K (12 μm)

CCDs + test structures

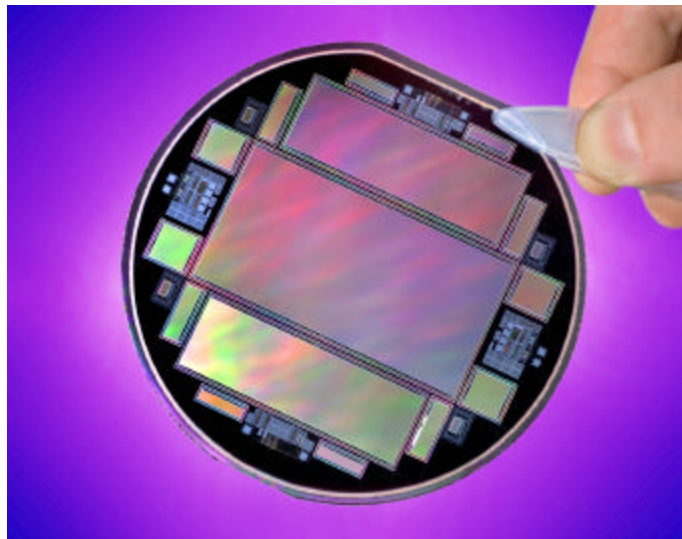

For more information see <http://snap.lbl.gov>

Medical Imaging – Positron Emission Tomography

(thanks to Bill Moses, Life Sciences Div. LBNL)

What is Positron Emission Tomography (PET)?

- Patient injected with drug having β^+ emitting isotope.
- Drug localizes in patient.
- Isotope decays, emitting β^+ .
- β^+ annihilates with e^- from tissue, forming back-to-back 511 keV photon pair.

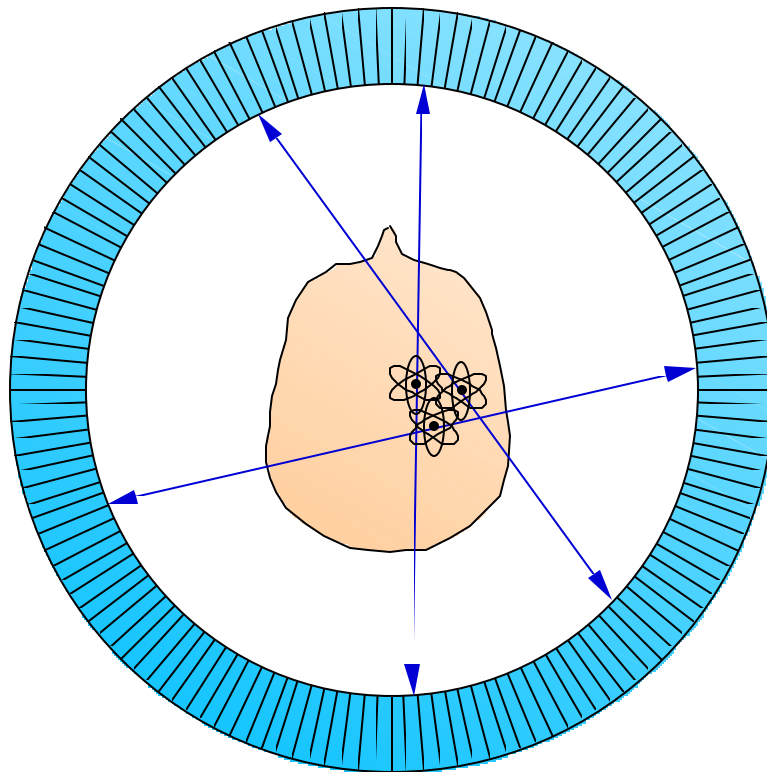

- 511 keV photon pairs detected via time coincidence.
- Positron lies on line defined by detector pair (a *chord*).

Forms planar image of a “slice” through the patient.

Common Tracer Isotopes

^{18}F	2 hour half life (+) Chemically "so-so" (\pm) Cyclotron-produced (-)
^{15}O , ^{11}C , ^{13}N	2 to 20 min. half-life (-) Chemically excellent (+) Cyclotron-produced (-)
^{82}Rb	2 min. half-life (-) Chemically boring (-) Generator-produced (+)

Individual Detector Element

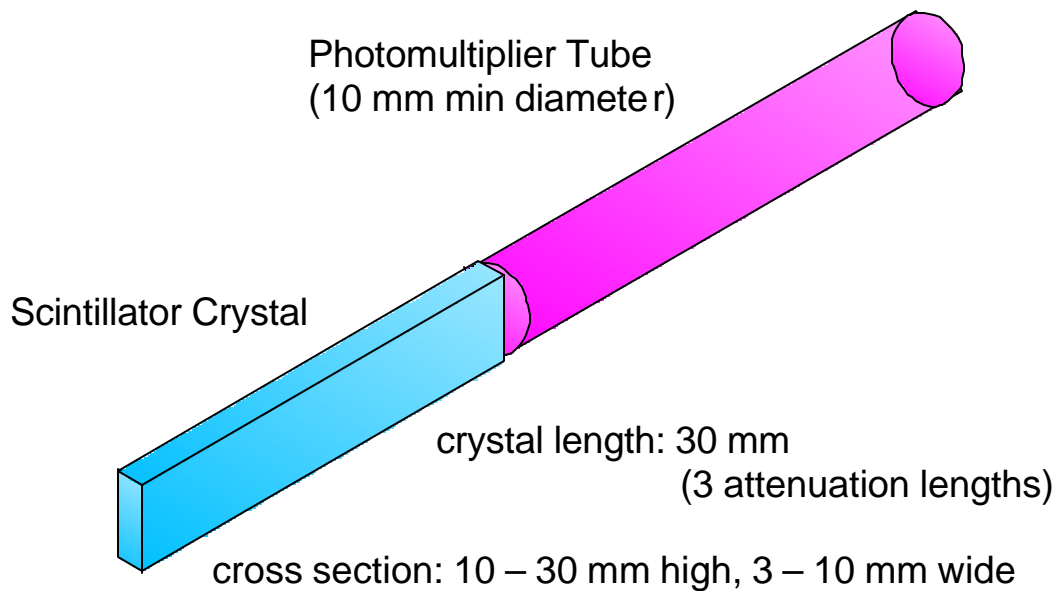

Scintillator converts photon energy into light
Photomultiplier tube converts light into electrical signal

Multi-Layer PET Cameras

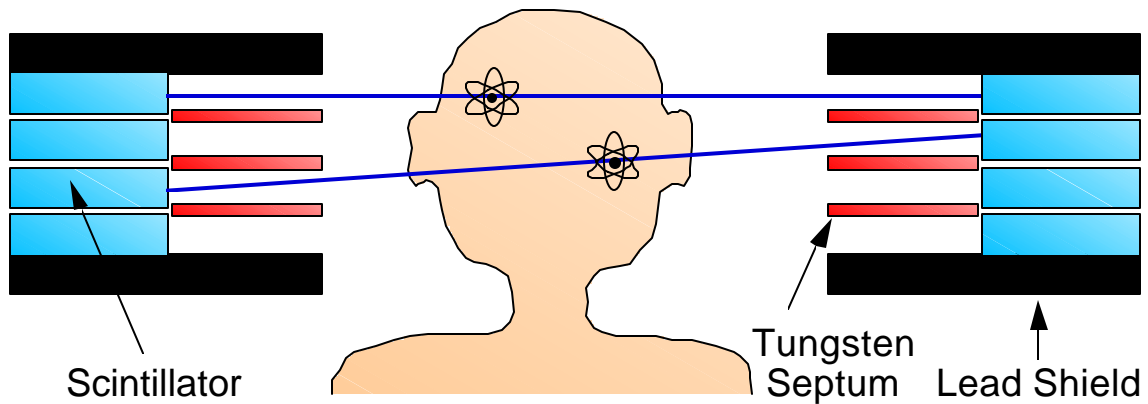

- Can image several slices simultaneously
- Can image cross-plane slices
- Can remove septa to increase efficiency (“3-D PET”)

However,

- More expensive

Planar images are “stacked” to form 3-D image

Time-of-Flight Tomograph

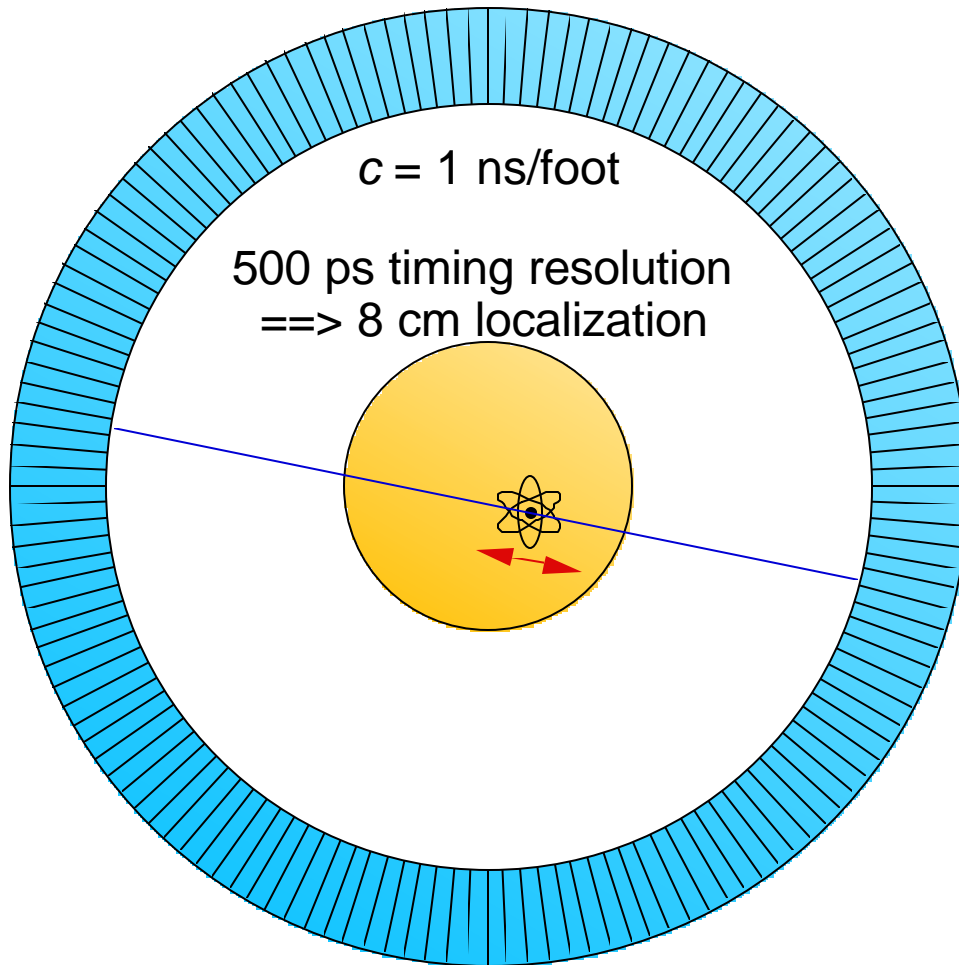

- Utilize difference in time of arrival between the two detectors
- Can localize source along line of flight
- Time-of-flight information reduces noise in images

However,

- Difficult to control timing of all detectors
- More expensive

Typically used to augment “standard” PET to reduce background.

Typical Tomograph Parameters

- Patient port 30 cm diameter (head machine) or 50 cm diameter (body machine).
- 3.5 to 6 mm scintillator crystal width.
- 24 to 48 layers, covering 15 cm axially.
- 8 liters of BGO scintillator crystal.
- 500 photomultiplier tubes.
- “Several” million dollars
 - Scintillator is 25% of total parts cost
 - PMTs are 25% of total parts cost
 - Next component is <5% total parts cost

Applications

Tumor vs. Necrosis

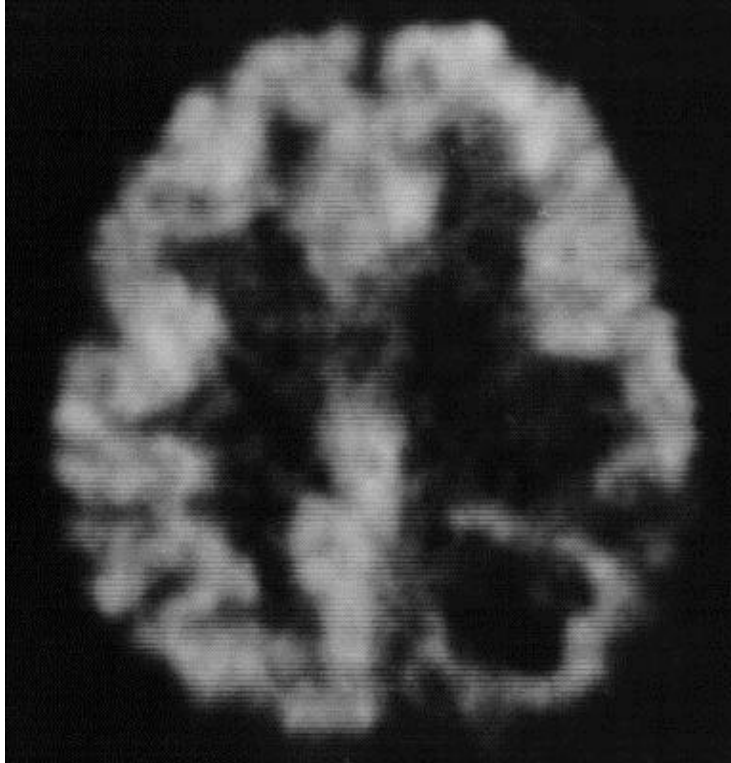

- Brain tumor treated by radiation therapy.
- Symptoms recur
- Too much or too little radiation
- Check with PET

Too much radiation **P** dead area

Too little radiation **P** rapid metabolism
 blood circulation increases
 tracer concentration

Epilepsy – Comparison of NMR with PET

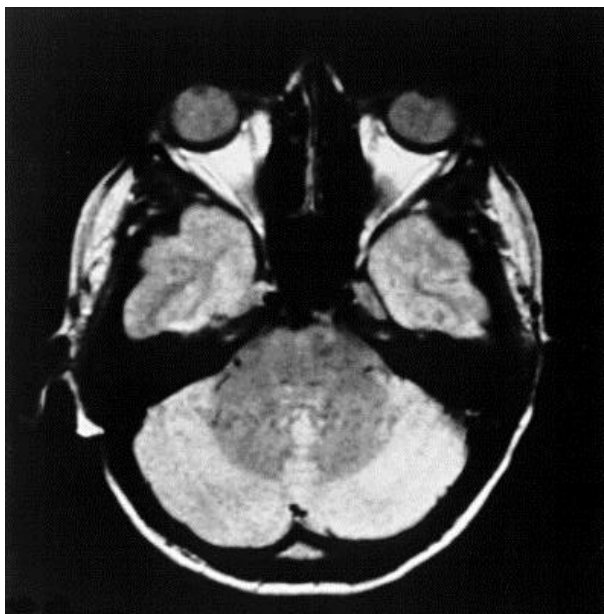

NMR
(now called MRI)

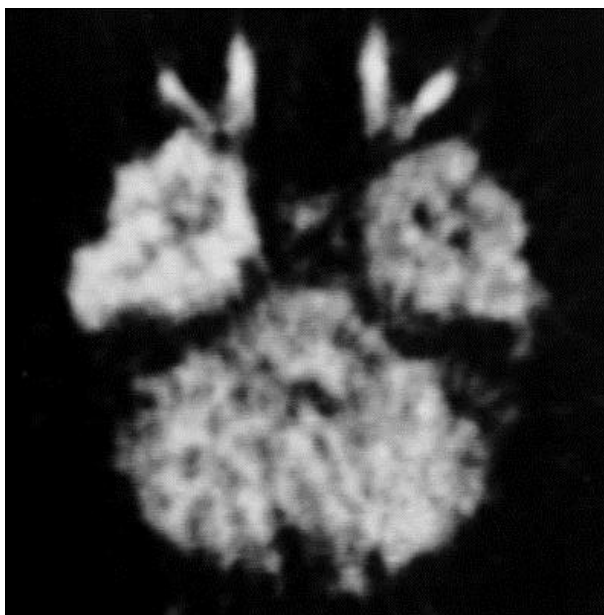

PET

note bright left
frontal lobe of brain

NMR and PET are complementary.

PET depends on rate of metabolism – allows dynamic measurements.

X-Ray Fluorescence

(thanks to Joe Jaklevic, Engineering Div. LBNL)

When excited by radiation of sufficient energy, atoms emit characteristic x-rays that can be used to detect trace contaminants.

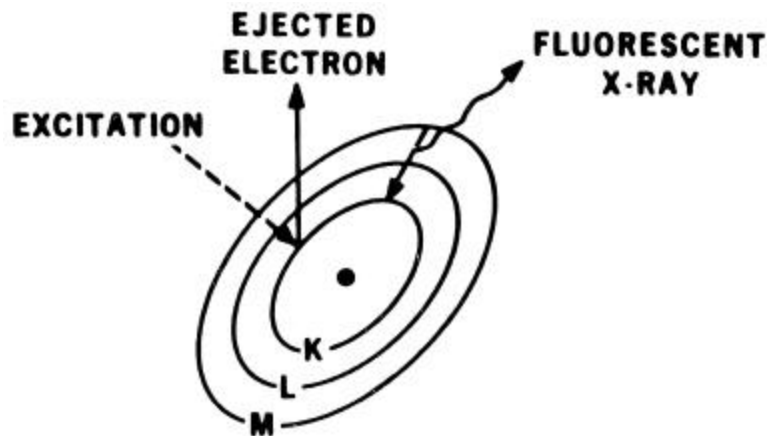

Experimental arrangement

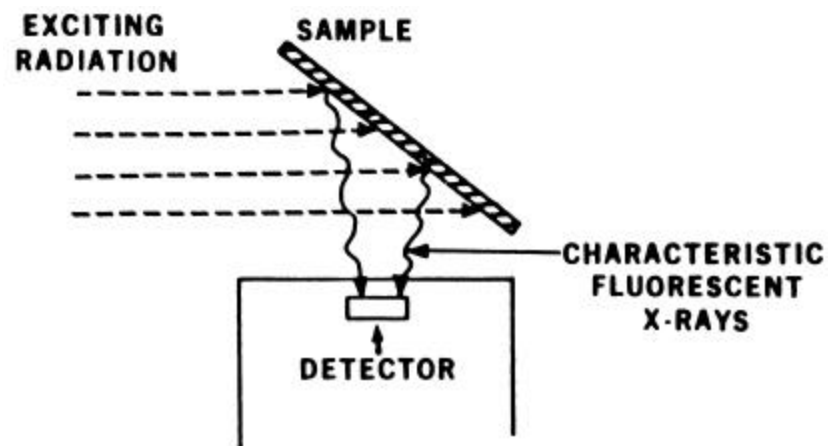

The incident radiation can be broad-band, as long as it contains components of higher energy than the atomic transitions of the atoms to be detected.

Energy of the K and L absorption edges vs. atomic number Z.

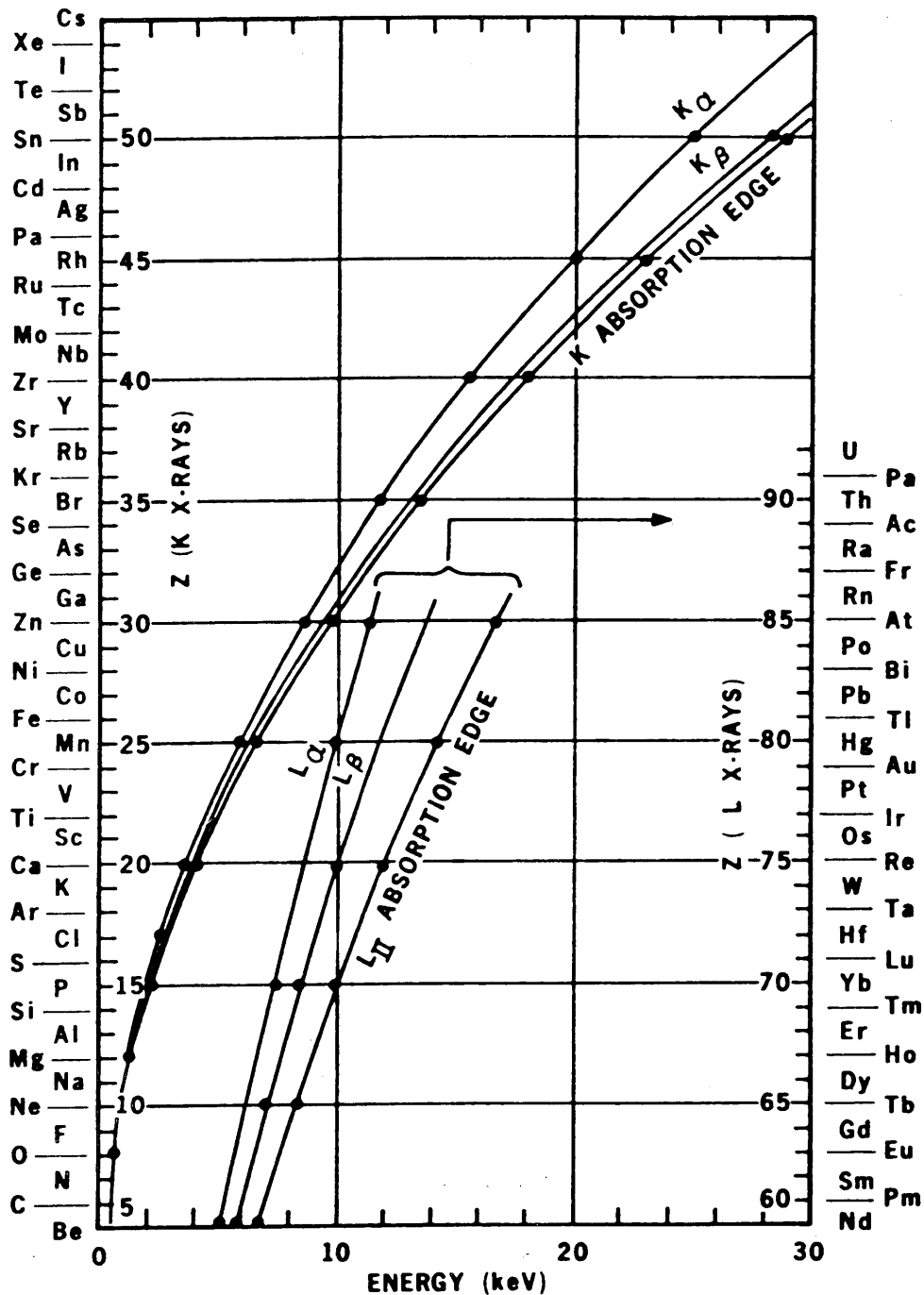

X-ray fluorescence can provide high sensitivity with small samples.

Spectrum taken from 2 ***nl*** (1 mm³) of blood.

Concentrations are given in parts per million

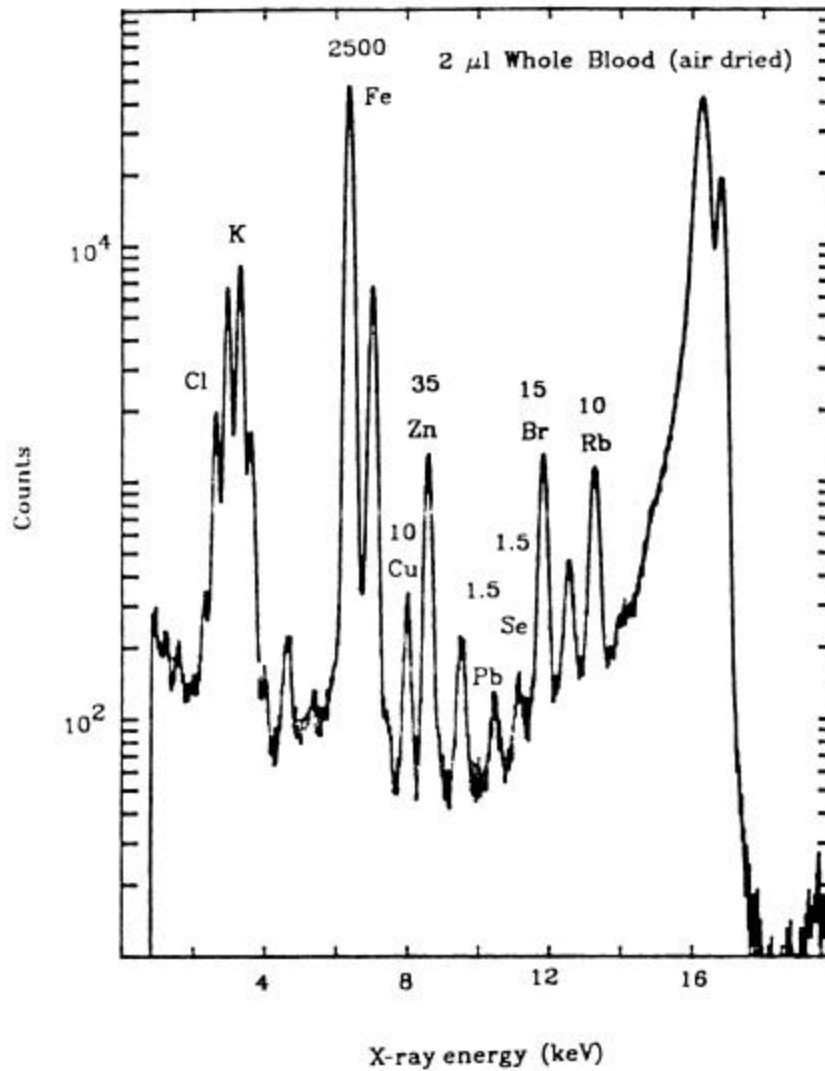

Note the Pb peak (measurement taken before the introduction of unleaded gasoline).

The sensitivity is limited by background.

In part, the signal-to-background ratio can be improved by judicious choice of the excitation energy.

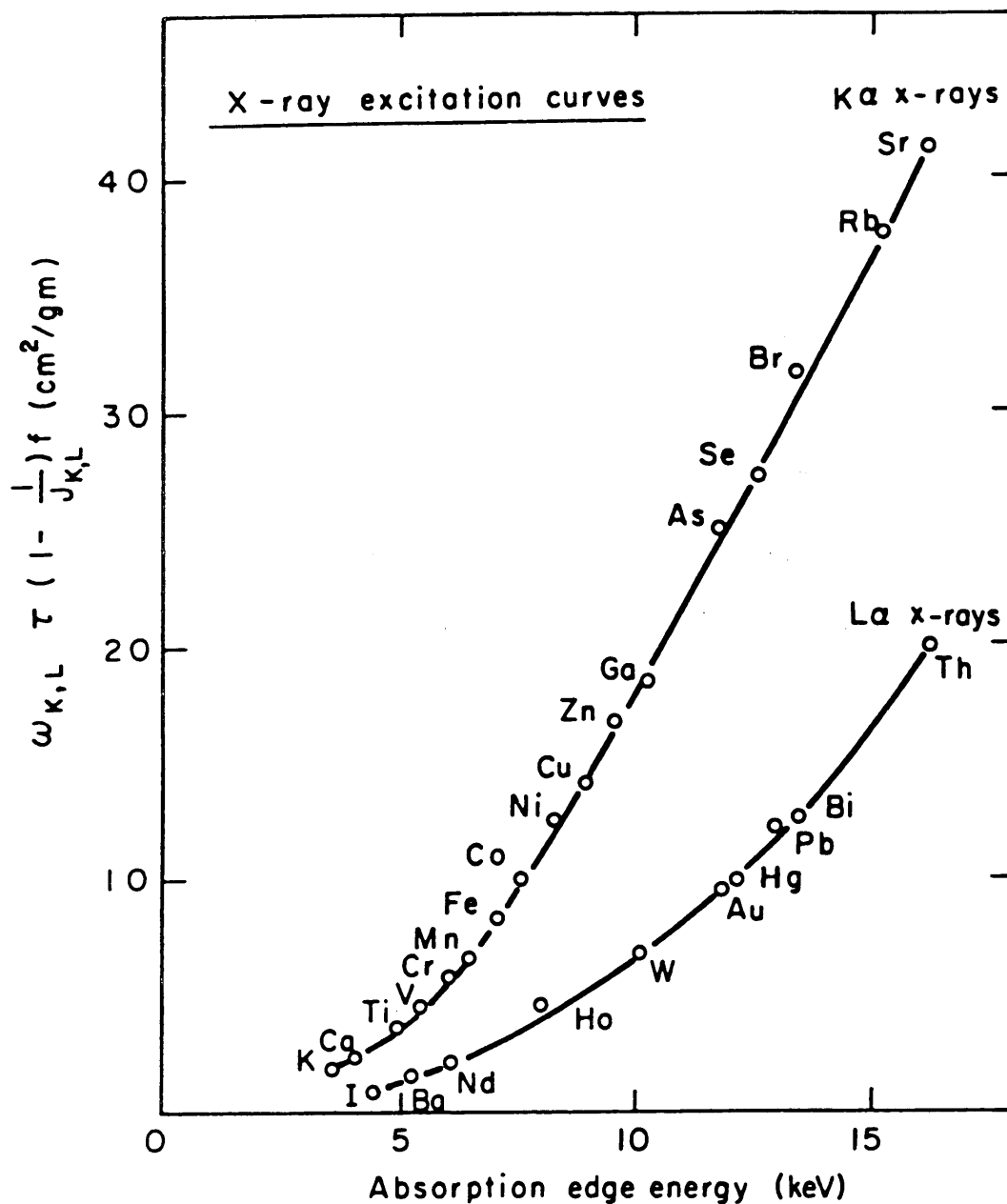

Note the increase in cross section with energy. Using the smallest possible excitation energy for a specific element reduces background from higher energy transitions.

Air sample, particles captured on filter, particle size $< 2.5 \mu\text{m}$.

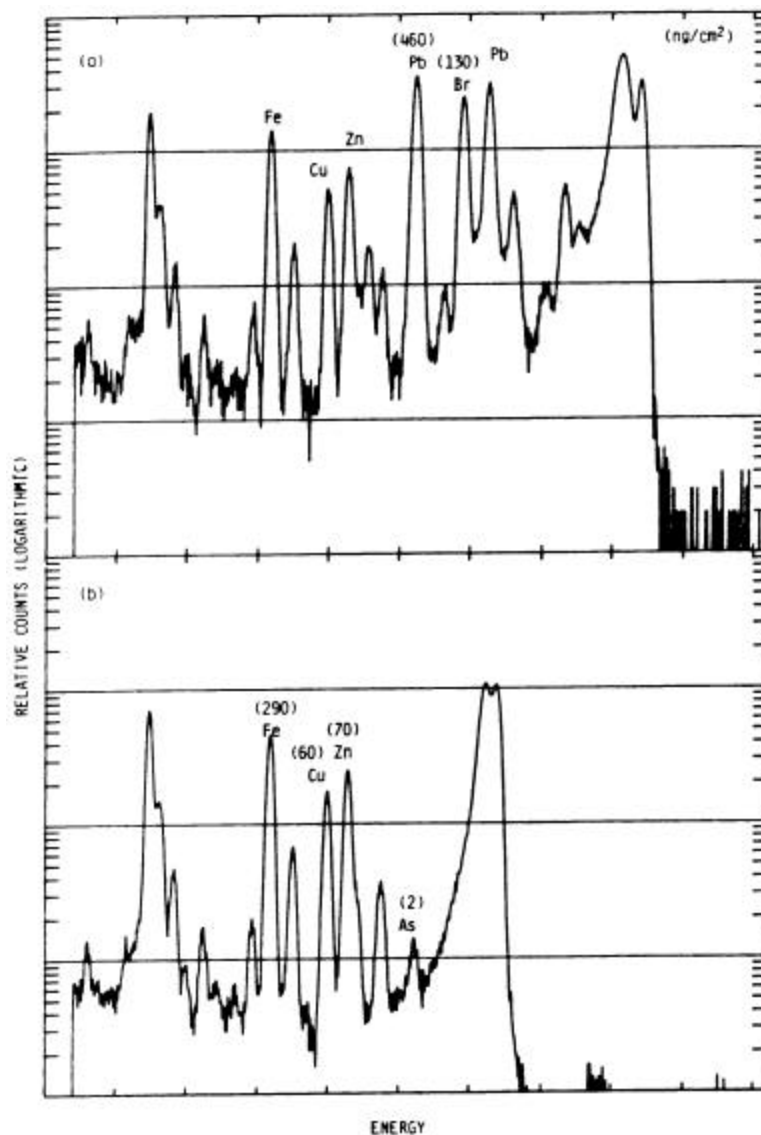

The upper edge of the spectrum indicates the excitation energy.

Note the As peak in the lower spectrum, which is obscured by more intense peaks from other elements at higher excitation.

At low excitation energies ($< 10 \text{ keV}$) emissions from high Z elements and high order transitions are significantly reduced.

Trace contaminants in milk powder, taken at two excitation energies.

Concentrations in ppm.

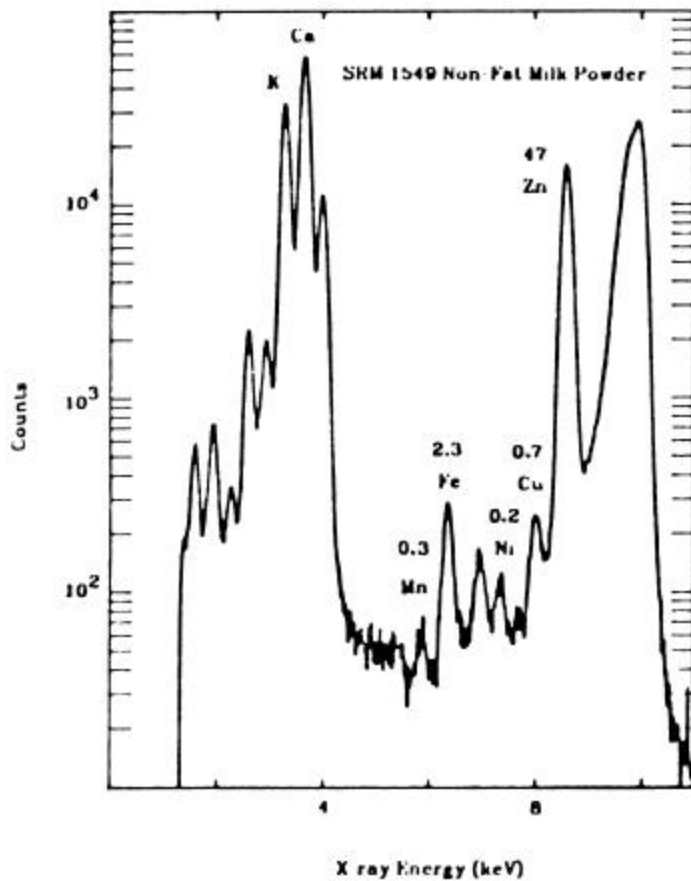
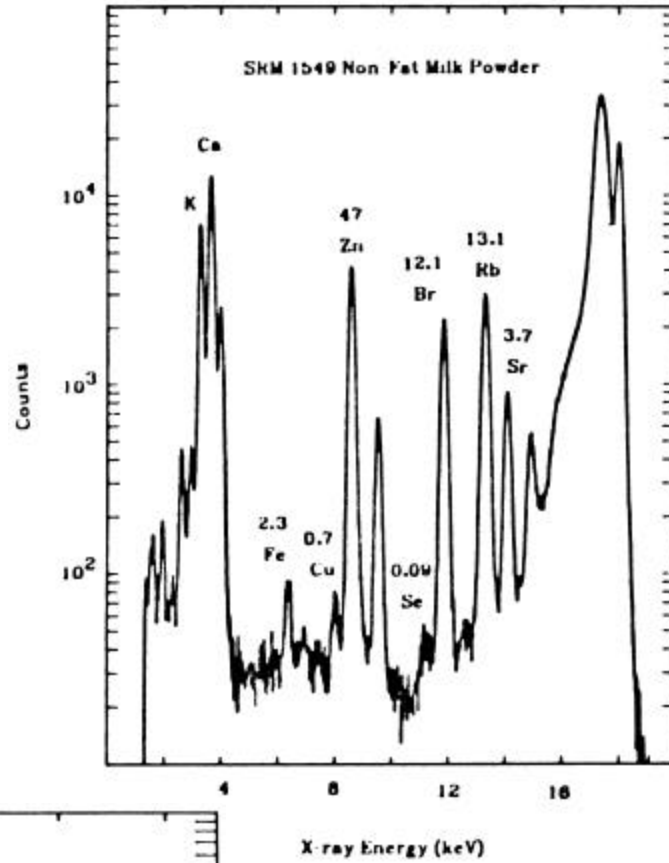

Reduced excitation energy:

Improved sensitivity for Mn, Ni.

Vertex Detection in High-Energy Physics

Detectors for high-energy physics comprise various subsystems to measure different parameters of the interaction products.

A typical detector at a colliding beam accelerator includes

1. Vertex detection
to determine the position of the primary interaction and secondary decays
2. Precision tracking in a magnetic field
momentum measurement
3. Calorimetry (Electromagnetic + Hadronic)
energy measurement
4. Muon detection

Vertex detectors have become critical components of modern detectors.

These systems rely on silicon sensors with 5 – 10 μm position resolution at radii of ~ 10 cm.

The high density of detector elements requires highly integrated readout electronics, monolithically integrated on silicon chips.

These readout ICs are highly specialized, so they are not available commercially. Determining the architecture and optimum technology, and then designing and system testing these ICs are among the main activities in the construction of large detector systems.

Typical configuration of a modern vertex detector

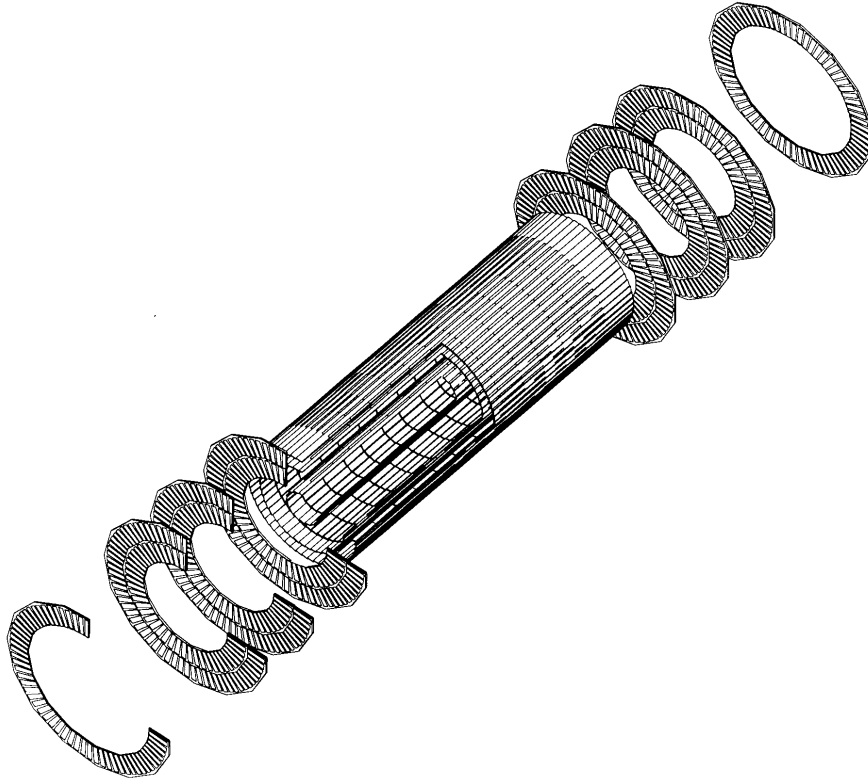

Resolution is provided primarily in azimuth, i.e.
 radial electrodes in the disks,
 electrodes parallel to the beam axis in the barrel:

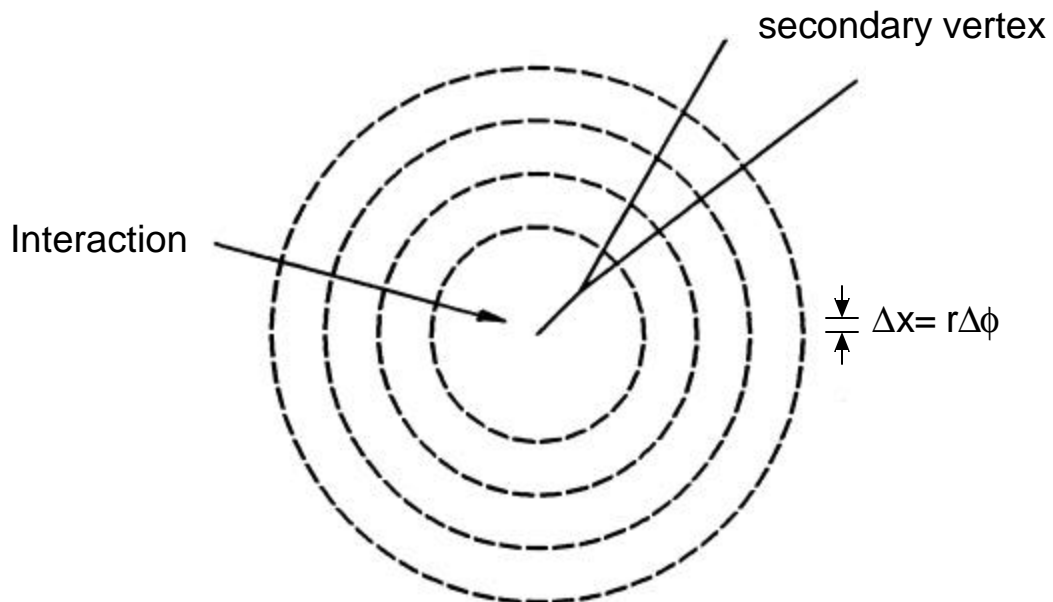

Discovery of Top Quark (CDF data)

Unique identification of the top quark by detecting secondary vertices in a high-resolution silicon vertex detector:

e + 4 jet event

40758_44414

24-September, 1992

TWO jets tagged by SVX

fit top mass is 170 +/- 10 GeV

e^+ , Missing E_T , jet #4 from top

jets 1,2,3 from top (2&3 from W)

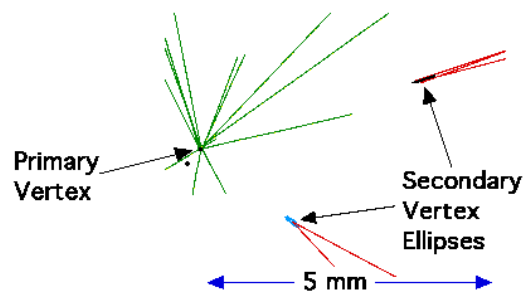
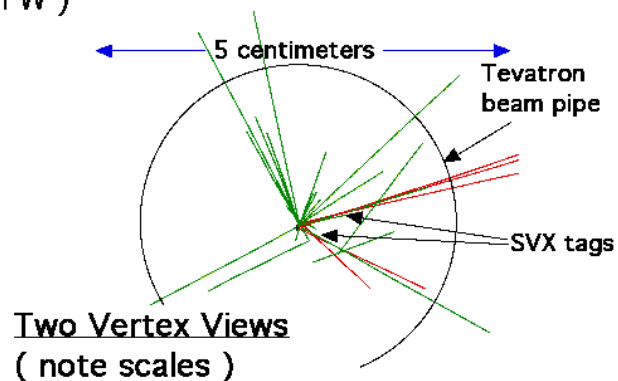
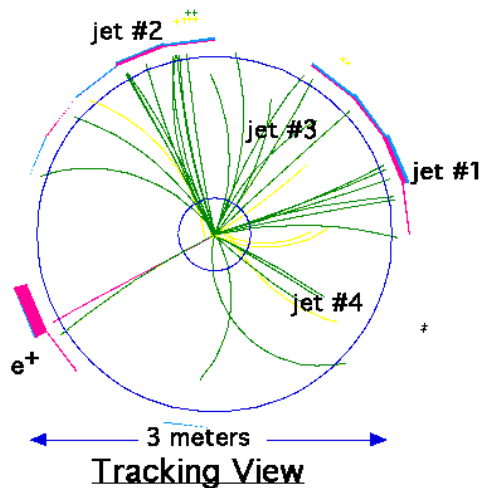
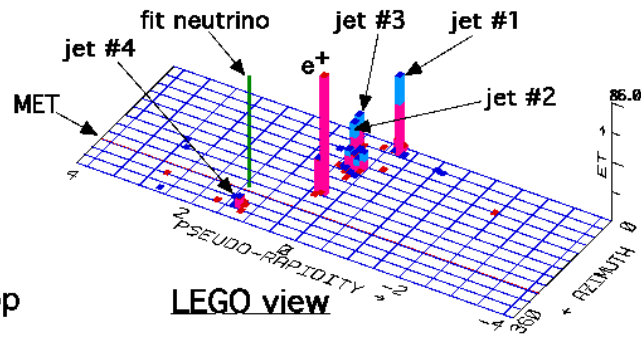

$$t\bar{t} \rightarrow W\bar{W}b\bar{b}$$

W has very short lifetime

$$W \rightarrow q\bar{q} \rightarrow 2 \text{ jets}$$

$$\bar{W} \rightarrow \text{positron} + \text{neutrino}$$

b emitted as B Meson, "long" lifetime

$$b, \bar{b} \rightarrow \text{displaced vertices}$$

↑
zoom in on displaced
vertices (next page)

$t\bar{t}$ Event SVX DISPLAY CDF

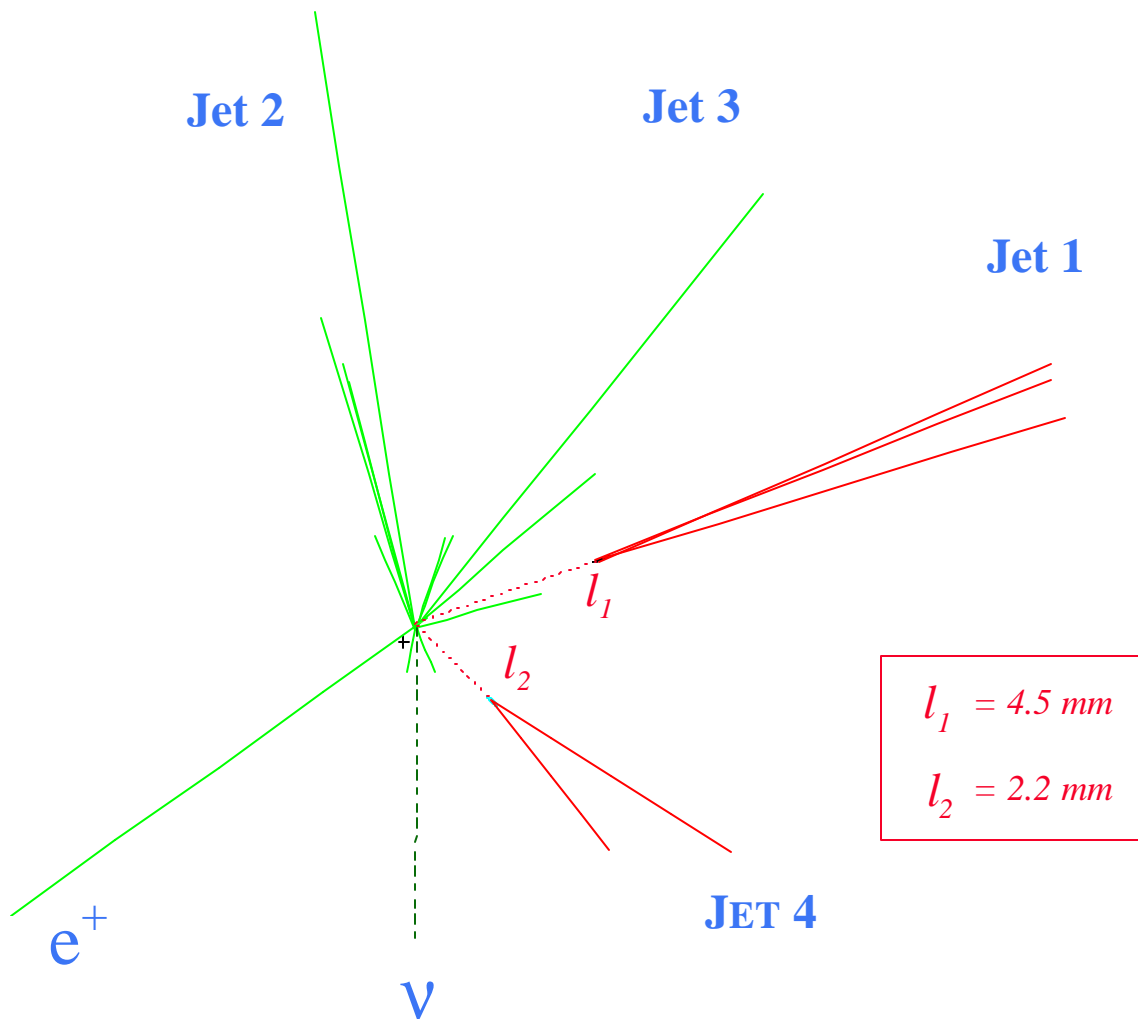

$$M_{\text{top}}^{\text{Fit}} = 170 \pm 10 \text{ GeV}/c^2$$

24 September, 1992
RUN #40758, EVENT #44414

A representative silicon detector module

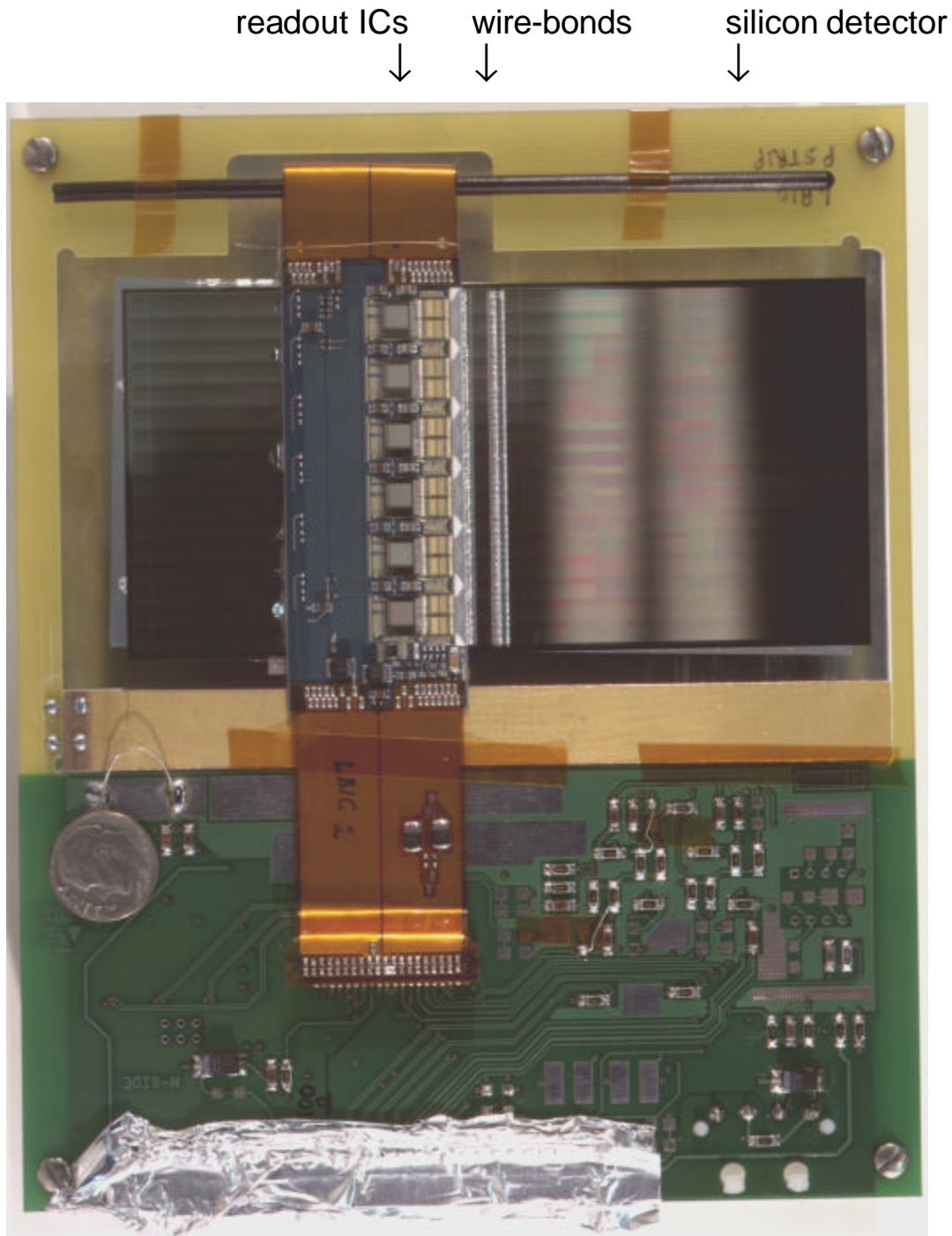

The module is mounted in a pc-board support frame to facilitate handling during test. The module itself is the rectangular object in the upper half of the picture.

In the course of developing the front-end ICs, poor fabrication yields led us to an extensive program of failure analysis.

One tool is to view IR images of chips. Defects can form localized high-field regions that allow electrons to acquire sufficient energy while traversing their mean free path to excite atomic transitions. Emission from these defect sites can be “seen” with appropriate position-sensitive sensors.

Data taken with T. Ohsugi at Hiroshima University.

1.2 x 1.5 mm² view of chip

Image at $\lambda = 1 \mu\text{m}$ (red) superimposed on visual image (gray/yellow)

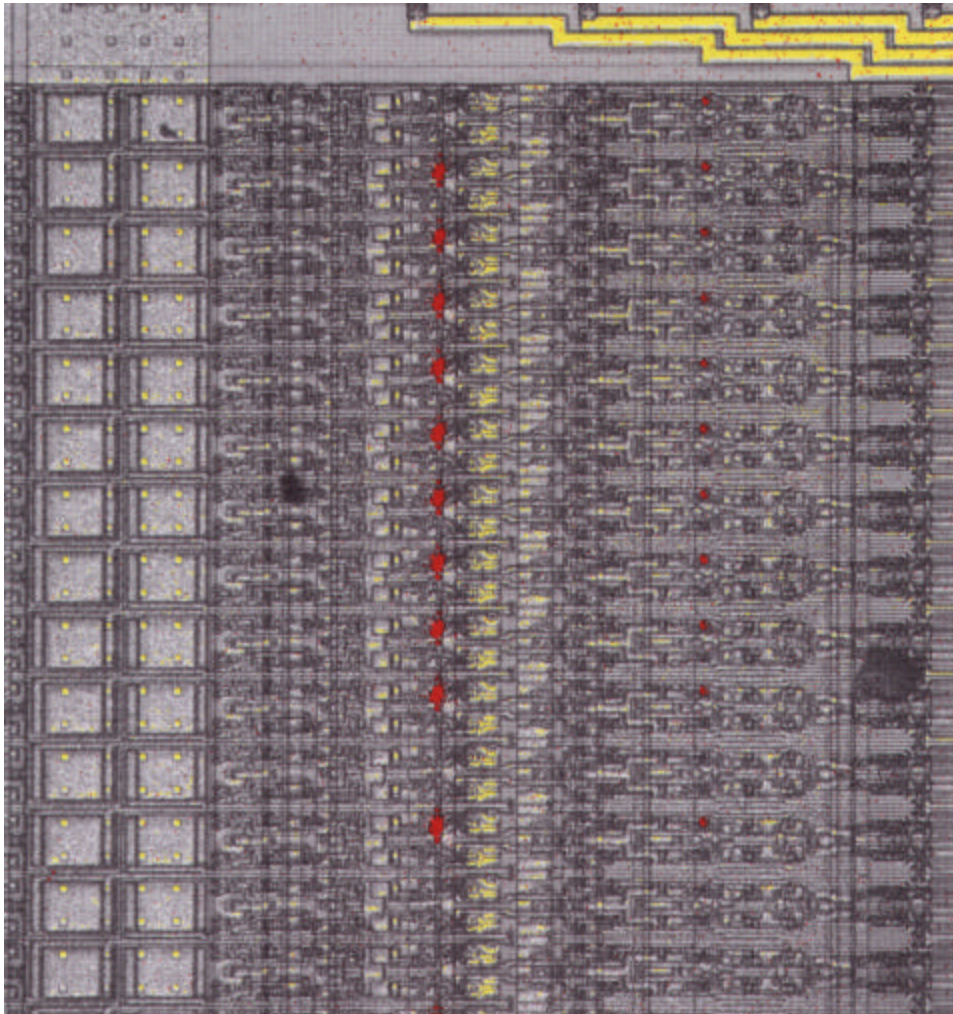

— —
red spots indicate IR emission

Viewing the emission sites at higher resolution allows the identification of individual transistors.

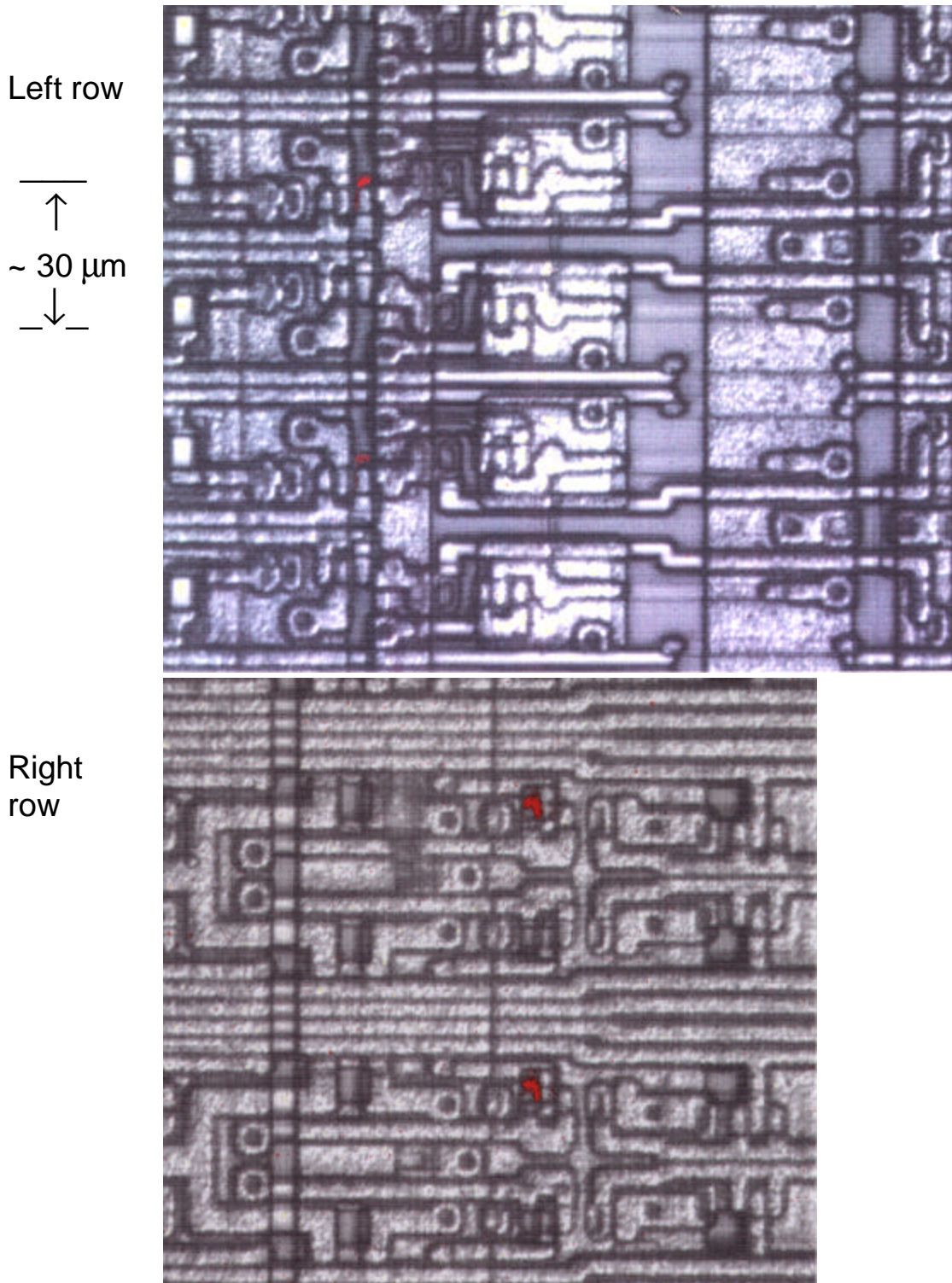

Since the aluminum metallization is opaque at 1 μm , the emission appears to “go around the corner”.

Detection of Gravity Waves

LISA is a next-generation space-based gravity wave detector.

Proposed as a joint ESA/NASA project the projected launch date is 2011.

Designed to complement ground-based experiments such as LIGO that are sensitive in the range 10 to 10^3 Hz, LISA will extend cover the range 10^{-4} to 10^{-1} Hz, with possible extensions down to 10^{-6} Hz.

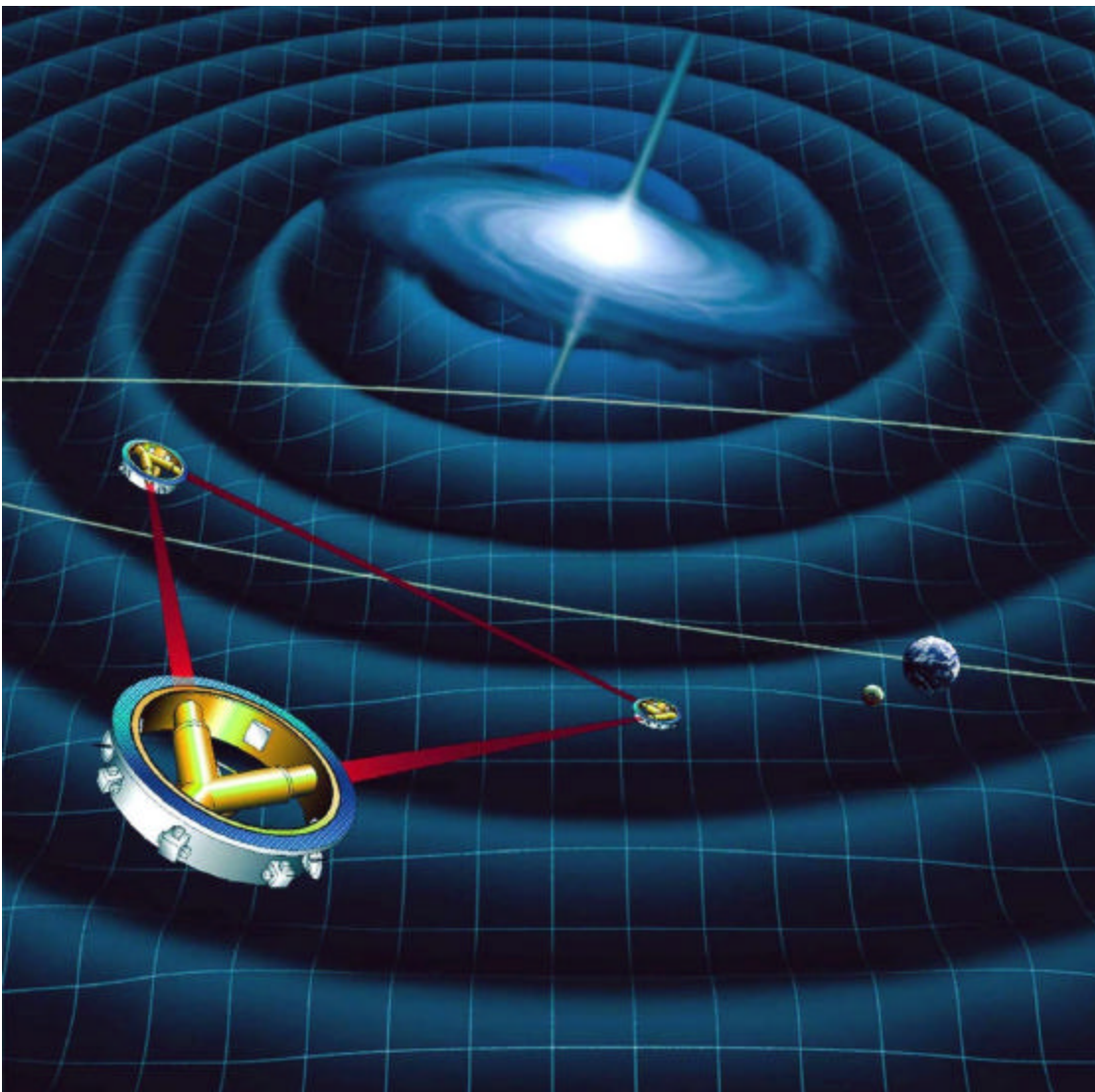

Artist's view of LISA, embedded in gravity wave field from a binary pulsar.

LISA consists of three proof masses at the three corners of an equilateral triangle.

The sides of the triangle are $5 \cdot 10^6$ km long; laser interferometry will control the spacing to $50 \mu\text{m}$.

The proof masses reside in individual spacecraft and are in free fall.

Gravity waves will displace the proof masses.

Coincident motion and the relative phase are indicators of the presence and source of gravity waves.

In the current design, capacitive sensors measure the displacement.

Extensions to lower frequencies will probably require more sophisticated position sensing.

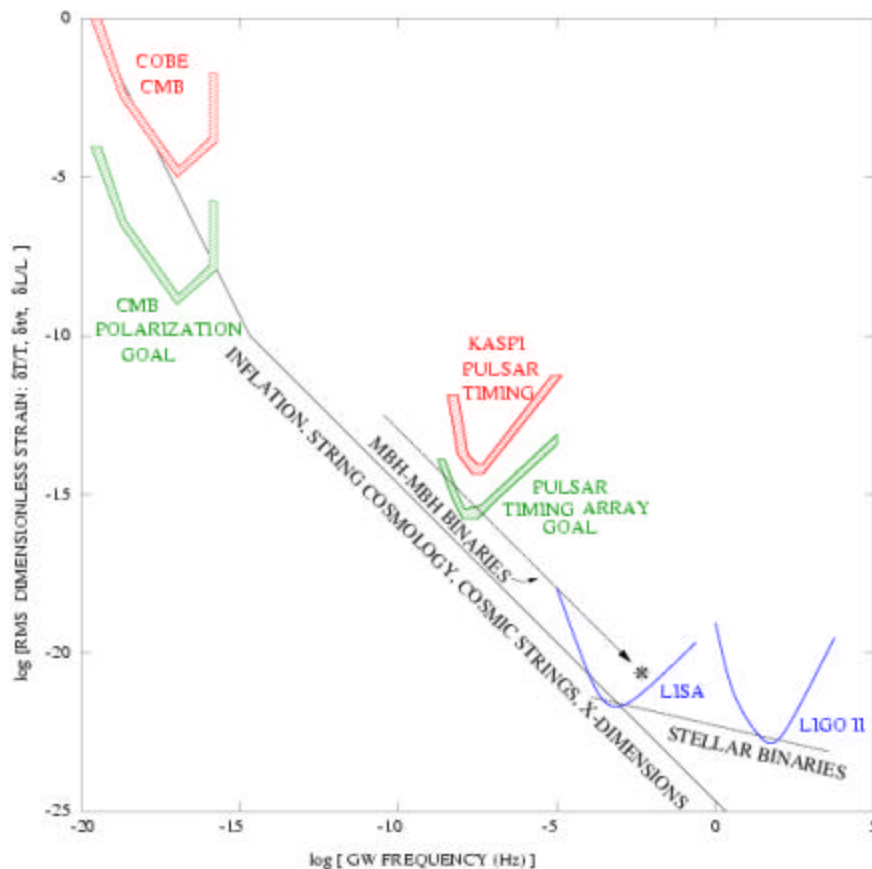

CMB measurements extend gravity wave measurements to the range $10^{-16} - 10^{-19}$ Hz.

3. The Problem

Radiation impinges on a sensor and creates an electrical signal.

The signal level is low and must be amplified to allow digitization and storage.

Both the sensor and amplifiers introduce signal fluctuations – noise.

1. Fluctuations in signal introduced by sensor
2. Noise from electronics superimposed on signal

The detection limit and measurement accuracy are determined by the signal-to-noise ratio.

How to optimize the signal-to-noise ratio?

1. Increase signal and reduce noise
2. For a given sensor and signal: reduce electronic noise

Assume that the signal is a pulse.

The time distribution of the signal corresponds to a frequency spectrum.

Examples:

Time Domain

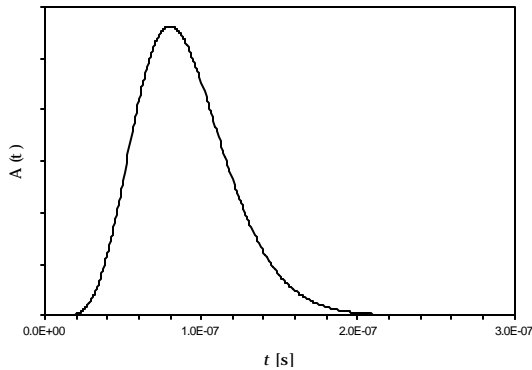

Frequency Domain

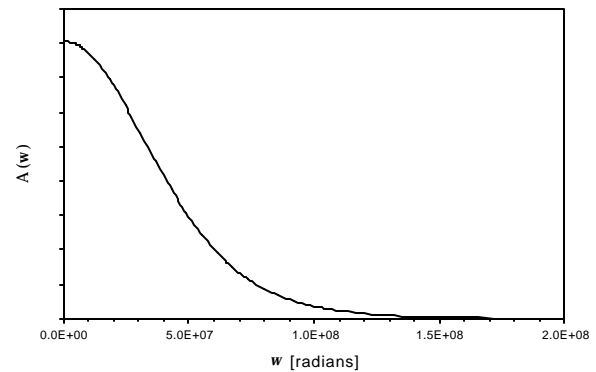

The pulse is unipolar, so it has a DC component and the frequency spectrum extends down to 0.

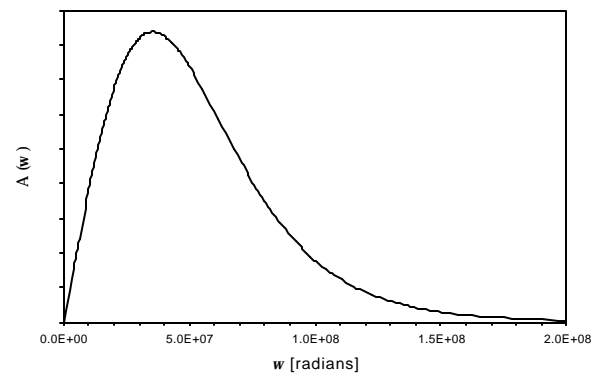
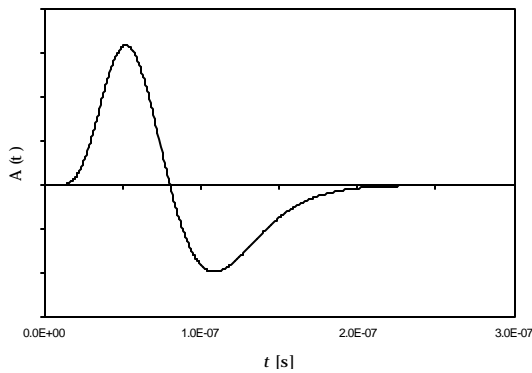

This bipolar pulse carries no net charge, so the frequency spectrum falls to zero at low frequencies.

The noise spectrum generally not the same as the signal spectrum.

Typical Noise Spectrum:

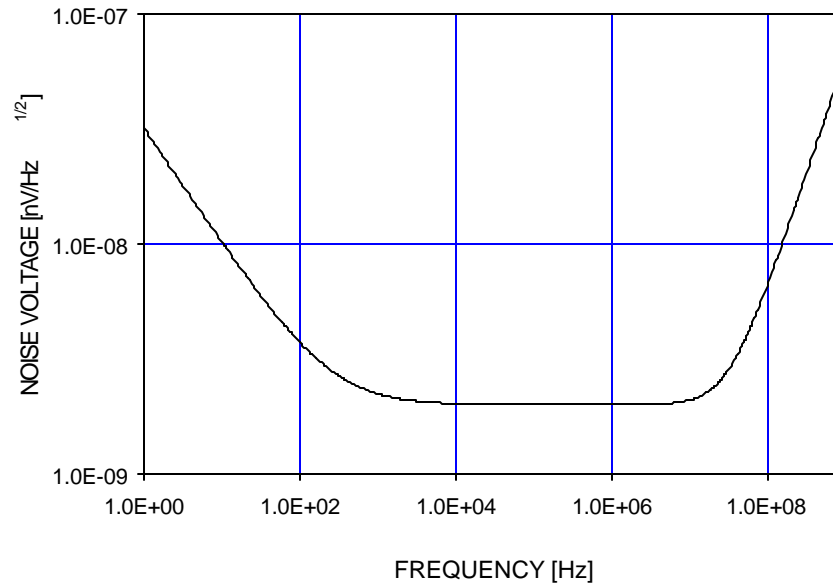

P tailor frequency response of measurement system to optimize signal-to-noise ratio.

Frequency response of measurement system affects both

- signal amplitude and
- noise.

There is a general solution to this problem:

Assume a signal $A_0 \cdot s(t)$ with the Fourier transform $A_0 \cdot S(\omega)$ whose shape is known, but not its amplitude A_0 .

Although $s(t)$ is real, generally, $S(\omega)$ will be complex.

The noise has a spectral power density $S_n(\omega) \equiv \frac{dP_n(\omega)}{d\omega}$.

The signal is to be evaluated at a time t_m .

We introduce a filter with the transfer function $H(\omega)$.

The signal at the output of a filter

$$g(t_m) = \frac{A_0}{2\pi} \int_{-\infty}^{\infty} H(\omega) \cdot S(\omega) e^{i\omega t_m} d\omega$$

and the output noise power

$$P_n = \frac{1}{2\pi} \int_{-\infty}^{\infty} |H(\omega)|^2 S_n(\omega) d\omega$$

The signal-to-noise ratio is maximal, when the filter function

$$H(\omega) = k \frac{S^*(\omega)}{S_n(\omega)} \cdot e^{-i\omega t_m}$$

where k is any constant. (see the appendix for a derivation)

If the noise spectrum is “white”, i.e. $S_n(\omega) = S_0$,

$$H(\omega) = KS^*(\omega) \cdot e^{-i\omega t_m}$$

The filter is the conjugate of the signal spectrum with an additional phase (or delay) factor $e^{-i\omega t_m}$.

Since $S = |S|e^{i\omega t}$ and its conjugate $S^* = |S|e^{-i\omega t}$, this corresponds to a mirroring in time and an additional shift by t_m , so its impulse response is

$$h_0(t) = s(t_m - t).$$

With this result it might appear that all we have to do is apply this recipe and all problems are solved.

Life is not so simple:

1. The optimum filter has an impulse response that is the signal pulse *mirrored in time* and shifted by the measurement time.

For example, if the signal pulse shape

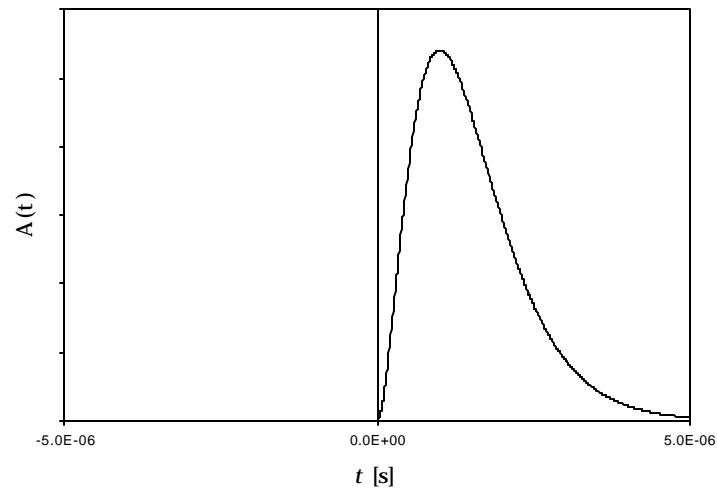

The response of the optimum filter

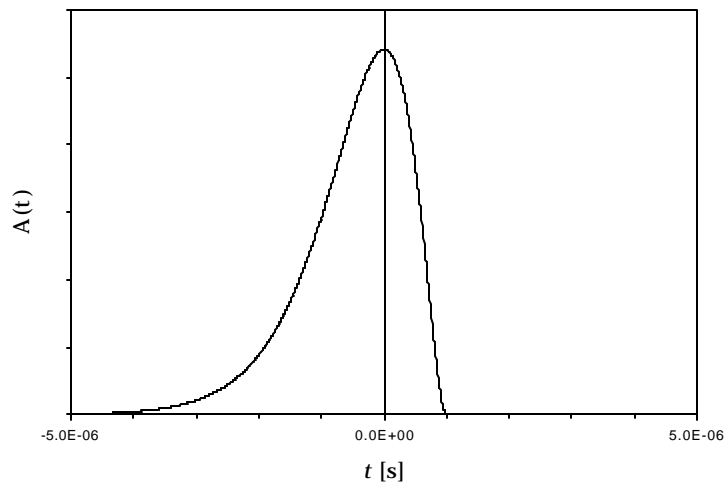

This is an “acausal” filter, i.e. it must act before the signal appears.

P only useful if the time of arrival is known in advance.

Not good for random events.

2. The raw detector signal is frequently not of the optimum form for the information that is required.

For example, a short rectangular detector pulse would imply a fast filter function. This retains both amplitude and timing information. If only amplitude information is required, this is not the optimum filter.

3. The optimum filter is often difficult or impractical to implement

Digital signal processing would seem to remove this restriction, but this approach is not practical for very fast signals or systems that require low power.

4. Simpler filters will often do nearly as well
5. Even a digital system requires continuous (“analog”) pre-processing.
6. It’s often useful to understand what you’re doing, so we’ll spend some more time to bring out the physical background of signal formation and processing.

Steps in analyzing a signal processing system:

1. determine the signal magnitude and time dependence

these will depend on how the measurement system is coupled to the sensor.

P detector models

2. Ascertain the origin and magnitude of fluctuations

signal fluctuations
random noise
external interference

3. design the filter

4. determine digitization and data readout scheme.

4. Example Measurement System

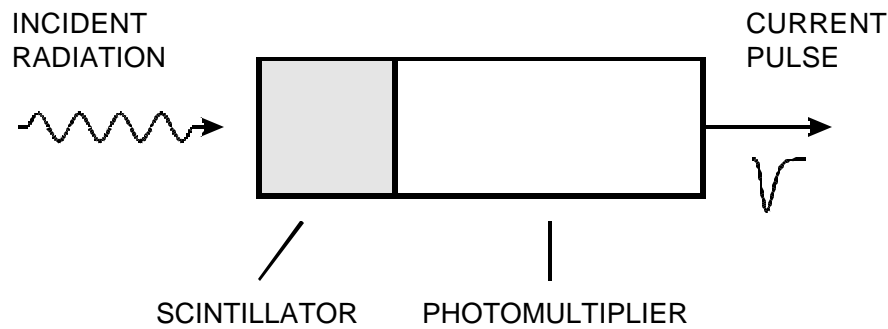

Processes in Scintillator – Photomultiplier

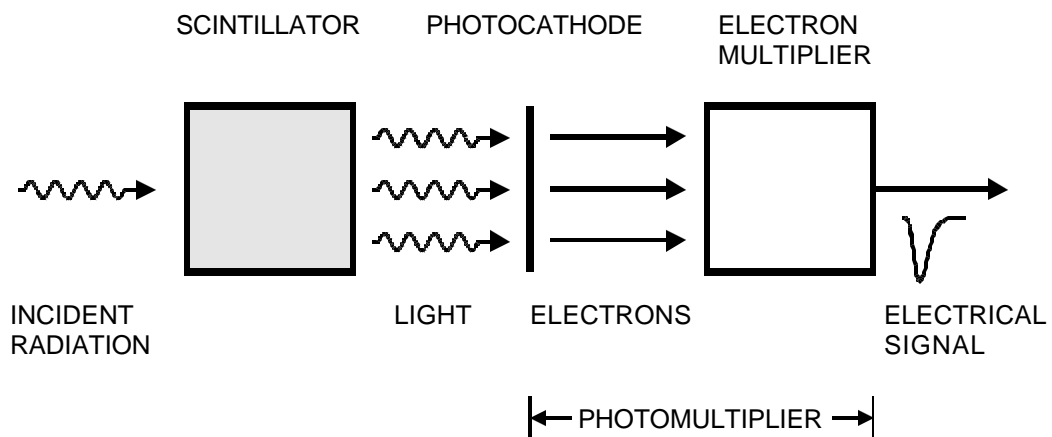

Signal Processing

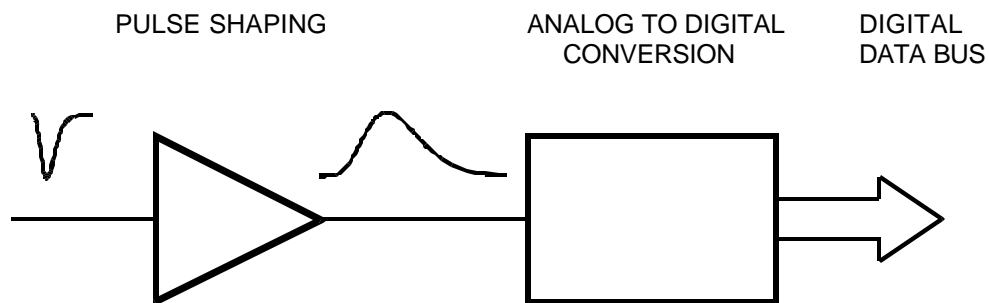

Large detector systems may consist of several subsystems especially designed to perform specific functions, for example

- position sensing (tracking)
- energy measurement (spectroscopy, calorimeters)
- timing
- particle identification

Functions

Although these subsystems may look very different and use radically differing technologies, they all tend to comprise the same basic functions:

1. Radiation deposits energy in a detecting medium.

The medium may be gas, solid or liquid.

In a tracking detector one wishes to detect the presence of a particle without affecting its trajectory, so the medium will be chosen to minimize energy loss and particle scattering.

Conversely, if one wishes to measure the total energy (energy spectrometry or calorimetry), the absorber will be chosen to optimize energy loss (high density, high Z).

2. Energy is converted into an electrical signal, either directly or indirectly. Each detected particle will appear as a pulse of electric charge.

Direct conversion:

incident radiation ionizes atoms/molecules in absorber, creating mobile charges that are detected.
(ionization chambers)

Indirect conversion:

incident radiation excites atomic/molecular states that decay by emission of light, which in a second step is converted into charge.
(scintillation detectors)

The primary signal charge is proportional to the energy absorbed.

Some typical values of energy required to form a signal charge of 1 electron:

gases	30 eV
semiconductors	1 to 10 eV
scintillators	20 to 500 eV

In neither of these schemes is the signal charge available instantaneously. In a scintillation detector the pulse duration is determined by the decay time of the optical transitions, in an ionization chamber the charges must move to the electrodes to obtain the full signal.

Typical pulse durations: 1 ns – 10 μ s

3. The electrical signal is amplified.

a) electronic circuitry

b) gain by secondary multiplication

primary charge is accelerated to sufficient energy for it to liberate additional charge carriers by impact ionization.

Examples: proportional chambers
 avalanche photodiodes
 photomultiplier

Both techniques may introduce significant random fluctuations (noise).

Ideally, a gain stage would increase only the magnitude of the pulse, without affecting its time dependence.

This ideal behavior is never strictly realized in practice, as it would require amplifiers with infinite bandwidth.

However, this is not a severe limitation, as in many applications it is quite acceptable and even desirable to change the pulse shape.

4. Pulse shaping (not always necessary, but always present in some form)

The time response of the system is tailored to optimize the measurement of signal magnitude or time and the rate of signal detection.

The output of the signal chain is a pulse (current or voltage) whose area is proportional to the original signal charge, i.e. the energy deposited in the detector.

Typically, the pulse shaper transforms a narrow detector current pulse to

a broader pulse
(to reduce electronic noise),
with a gradually rounded maximum at the peaking
time T_P
(to facilitate measurement of the amplitude)

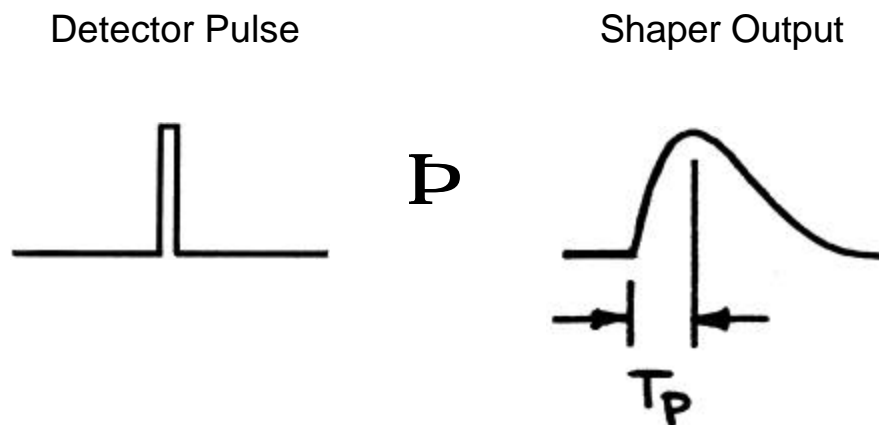

If the shape of the pulse does not change with signal level, the peak amplitude is also a measure of the energy, so one often speaks of pulse-height measurements or pulse height analysis. The pulse height spectrum is the energy spectrum.

5. Digitization of

- a) signal magnitude
(analog-to-digital converter, viz. ADC or A/D)

Example:

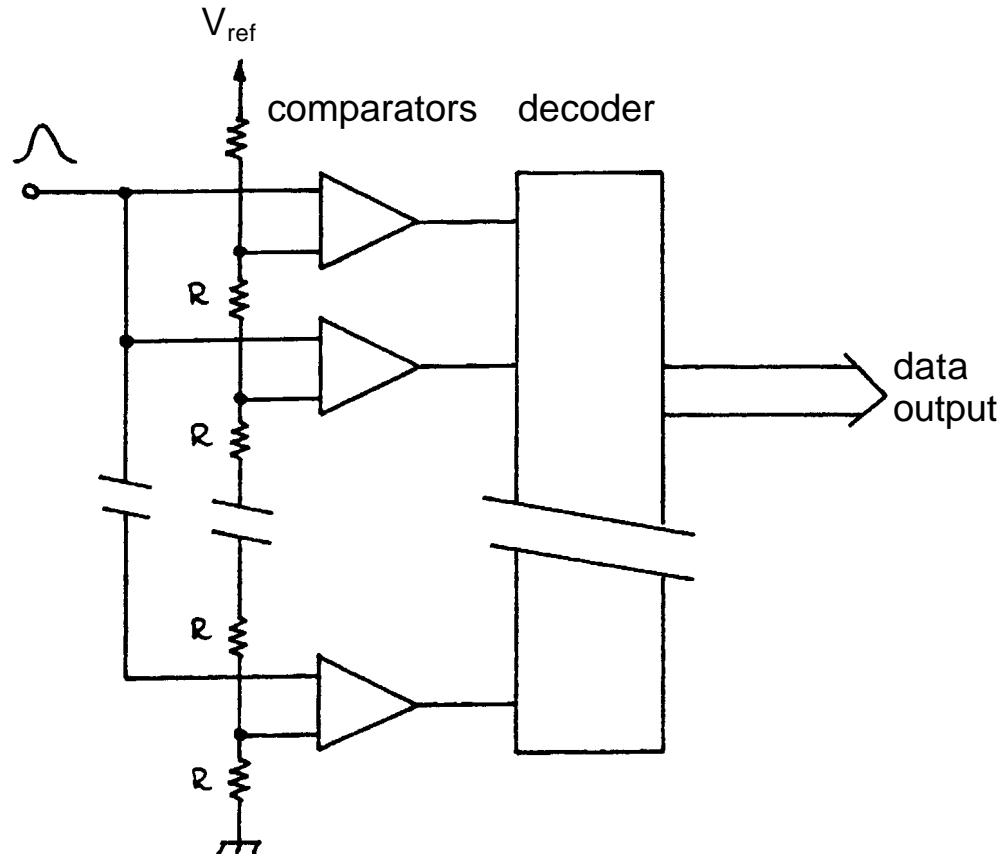

The input signal is applied to n comparators in parallel. The switching thresholds are set by a resistor chain, such that the voltage difference between individual taps is equal to the desired measurement resolution.

In the presence of a signal all comparators with threshold levels less than the signal amplitude will fire. A decoder converts the parallel bit pattern into a more efficient form, for example binary code.

This type of ADC is fast, but requires as many comparators as measurement bins. Other converter types provide higher resolution and simpler circuitry at the expense of speed.

- b) time difference between the detected signal and a reference signal
(time-to-digital converter, TDC)

The reference signal can be derived from another detector (as in TOF-PET) or from a common system clock, the crossing time of colliding beams, for example.

Circuit implementations include schemes that count “clock ticks” in fully digital circuitry or combine time-to-amplitude and amplitude-to-digital conversion in mixed analog-digital arrangements.

In complex detector systems the individual digitized outputs may require rather complex circuitry to combine the signal associated with a specific event and “package” them for efficient transfer.